



HCF65R260

650V N-Channel Super Junction Power MOSFET

●Features:

- 15.0A, 650V, $R_{DS(on)(Typ)} = 220m\Omega @ V_{GS}=10V$
- Ultra Low Gate Charge
- Ultra Low C_{rss}
- 100% Avalanche Tested
- Fast Switching
- Improved dv/dt Capability

●Application:

- High Frequency Switching Mode Power Supply
- Active Power Factor Correction

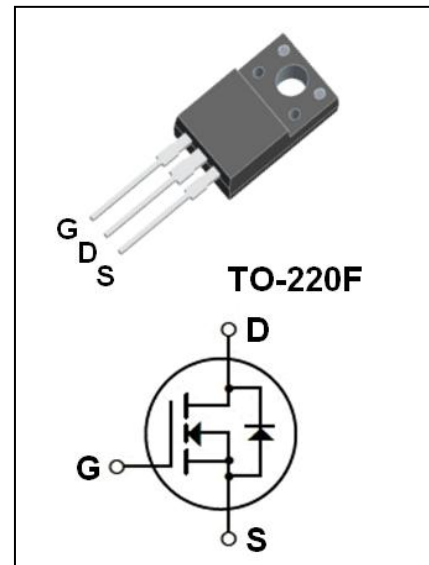

Absolute Maximum Ratings ($T_c=25^\circ C$ unless otherwise noted)

Symbol	Parameter	Value	Unit
V_{DSS}	Drain-Source Voltage	650	V
V_{GSS}	Gate-Source Voltage	± 30	V
I_D	Drain Current	- Continuous ($T_c=25^\circ C$)	15.0*
		- Continuous ($T_c=100^\circ C$)	10.0*
I_{DM}	Drain Current - Pulsed (Note1)	60*	A
P_D	Power Dissipation ($T_c = 25^\circ C$) - Derate above $25^\circ C$	33.2	W
		0.265	W/ $^\circ C$
E_{AS}	Single Pulsed Avalanche Energy (Note2)	304	mJ
I_{AR}	Avalanche Current (Note1)	3	A
E_{AR}	Repetitive Avalanche Energy, t_{AR} limited by T_{jmax} (Note1)	1.6	mJ
dv/dt	Drain Source voltage slope, $V_{DS} \leq 480V$	50	V/ns
dv/dt	Reverse diode dv/dt, $V_{DS} \leq 480V, I_{SD} \leq I_D$	15	V/ns
T_j	Operating Junction Temperature	150	$^\circ C$
T_{stg}	Storage Temperature Range	-55 to +150	$^\circ C$

* Drain Current Limited by Maximum Junction Temperature.

Thermal Characteristics

Symbol	Parameter	Max	Unit
$R_{\theta JC}$	Thermal Resistance, Junction to Case	3.76	$^\circ C / W$
$R_{\theta JA}$	Thermal Resistance, Junction to Ambient	62.5	$^\circ C / W$



HCF65R260

650V N-Channel Super Junction Power MOSFET

Electrical Characteristics (Tc=25°C unless otherwise noted)

Symbol	Parameter	Test Conditions	Min	Typ	Max	Unit
Off Characteristics						
BV _{DSS}	Drain-source Breakdown Voltage	V _{GS} =0V, I _D =250μA	650	--	--	V
I _{DSS}	Zero Gate Voltage Drain Current	V _{DS} =650V, V _{GS} =0V	--	--	1	μA
		V _{DS} =650V, Tc=125°C	--	--	100	μA
I _{GSSF}	Gate-Body Leakage Current, Forward	V _{GS} =+30V, V _{DS} =0V	--	--	100	nA
I _{GSSR}	Gate-Body Leakage Current, Reverse	V _{GS} =-30V, V _{DS} =0V	--	--	-100	nA
On Characteristics						
V _{GS(th)}	Gate Threshold Voltage	V _{DS} =V _{GS} , I _D =250μA	3.0	--	4.0	V
R _{DS(on)}	Static Drain-Source On-Resistance	V _{GS} =10 V, I _D =10.0A	--	220	260	mΩ
Dynamic Characteristics						
C _{iss}	Input Capacitance	V _{DS} =50V, V _{GS} =0V, f=1.0MHz	--	1210	--	pF
C _{oss}	Output Capacitance		--	74	--	pF
C _{rss}	Reverse Transfer Capacitance		--	0.2	--	pF
Q _g	Total Gate Charge	V _{DS} = 480V, I _D = 15 A, V _{GS} = 10 V	--	24.7	--	nC
Q _{gs}	Gate-Source Charge		--	8.2	--	nC
Q _{gd}	Gate-Drain Charge		--	8.5	--	nC
Switching Characteristics						
t _{d(on)}	Turn-On Delay Time	V _{DD} = 380V, I _D = 15 A, R _G = 25 Ω, V _{GS} = 10 V	--	14	--	ns
t _r	Turn-On Rise Time		--	8	--	ns
t _{d(off)}	Turn-Off Delay Time		--	55	--	ns
t _f	Turn-Off Fall Time		--	7	--	ns
Drain-Source Diode Characteristics and Maximum Ratings						
I _{SD}	Maximum Continuous Drain-Source Diode Forward Current		--	--	15	A
I _{SDM}	Maximum Pulsed Drain-Source Diode Forward Current		--	--	60	A
V _{SD}	Drain-Source Diode Forward Voltage	T _J = 25°C , V _{GS} = 0V, I _{SD} = 15A	--	--	1.2	V
t _{rr}	Reverse Recovery Time	T _J = 25°C , I _F = 7.5A, dI _F /dt = 100A/μs	--	240	--	ns
Q _{rr}	Reverse Recovery Charge		--	2	--	μC
I _{rrm}	Peak Reverse Recovery Current		--	17	--	A

Notes:

- 1、Repetitive Rating: Pulse Width Limited by Maximum Junction Temperature.
- 2、T_J = 25°C, V_{DD} = 50V, V_G = 10V, R_G = 25 Ω.



HCF65R260

650V N-Channel Super Junction Power MOSFET

On-Regin Characteristics

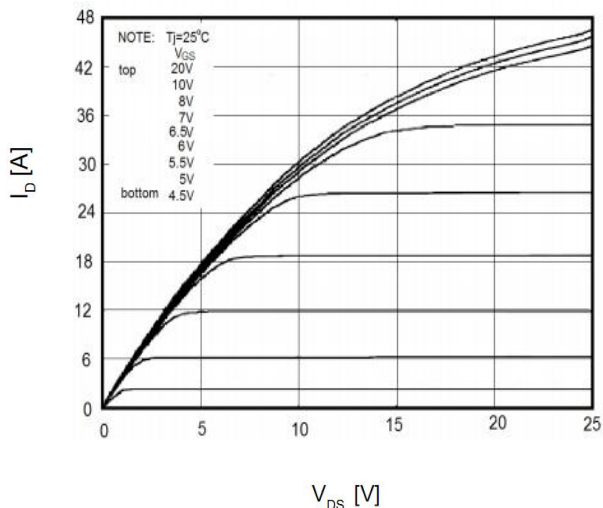

Transfer Characteristics

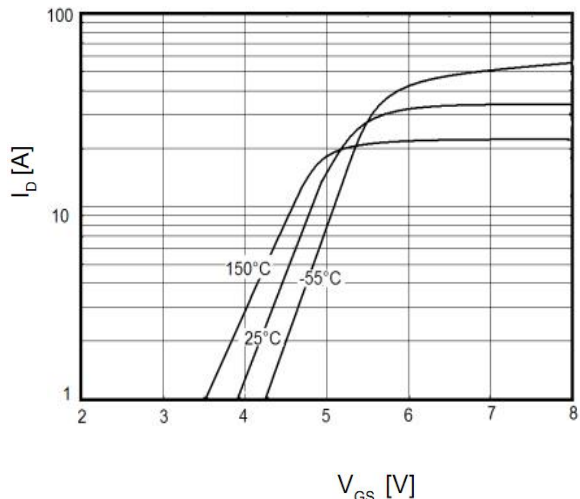

On-Resistance Variation vs. Drain Current and Gate Voltage

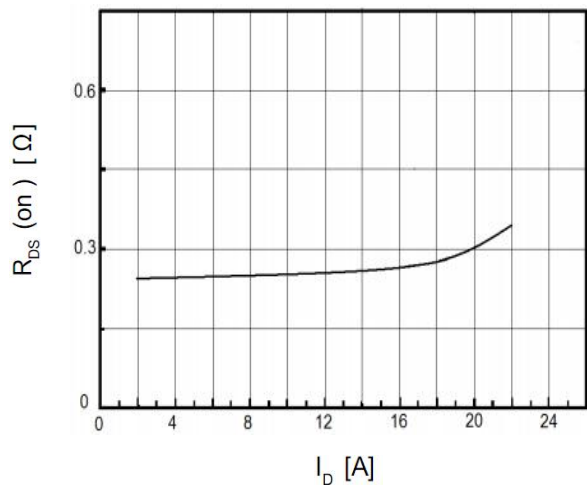

Body Diode Forward Voltage Variation vs. Source Current and Temperature

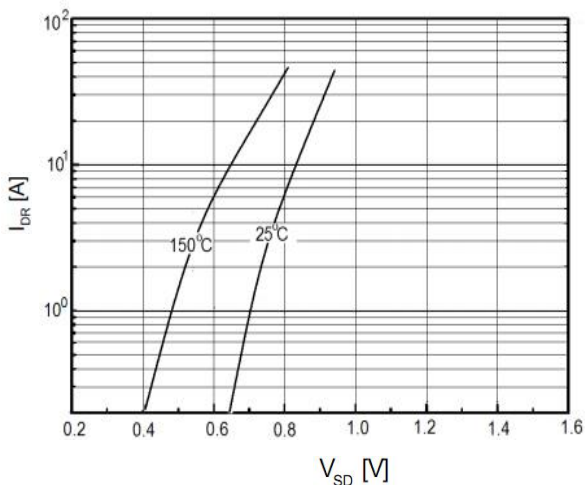

Capacitance Characteristics

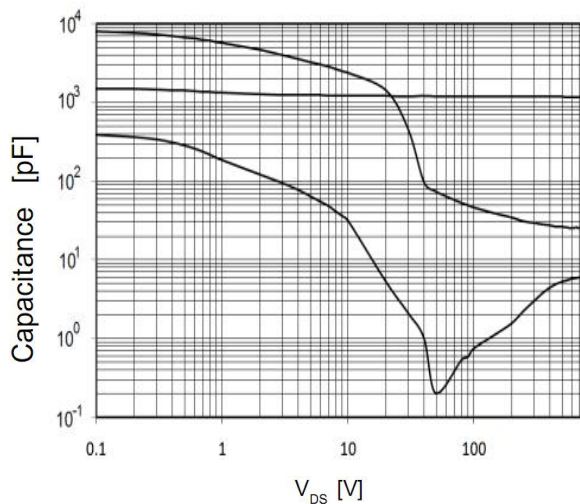

Gate Charge Characteristics

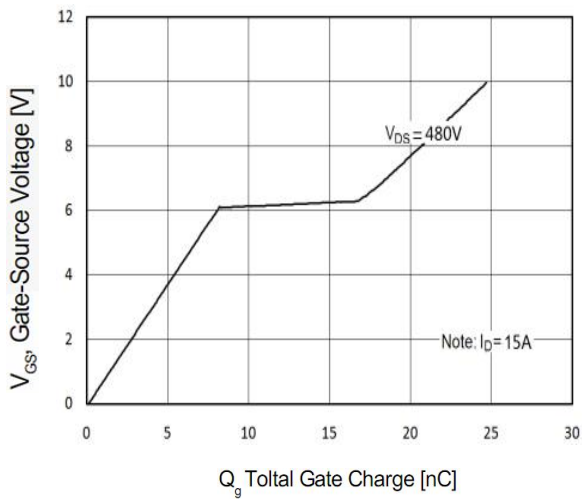



HCF65R260

650V N-Channel Super Junction Power MOSFET

Breakdown Voltage Variation vs. Temperature

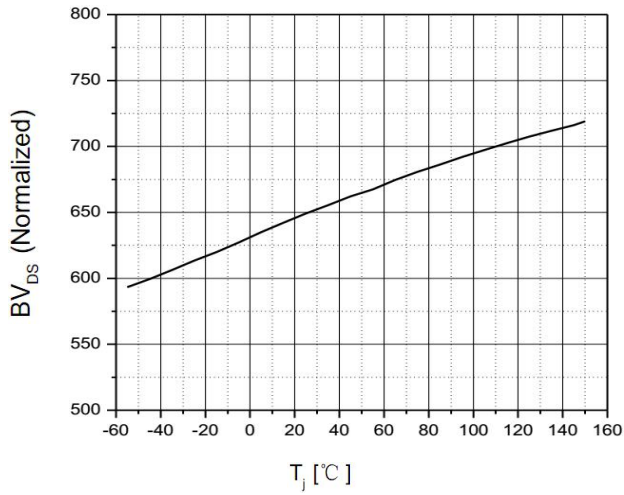

On-Resistance Variation vs. Temperature

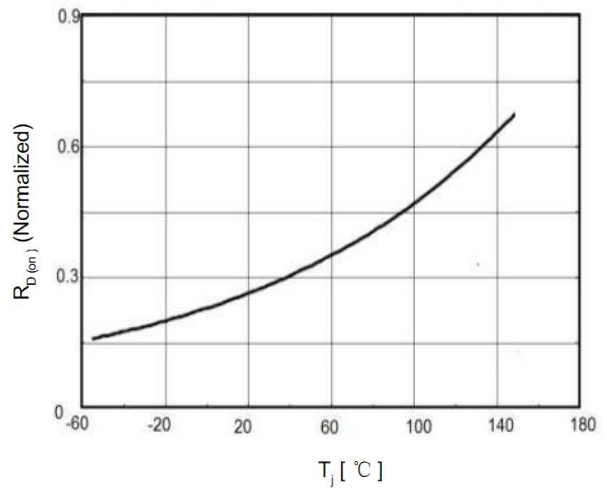

Maximum Safe Operating Area

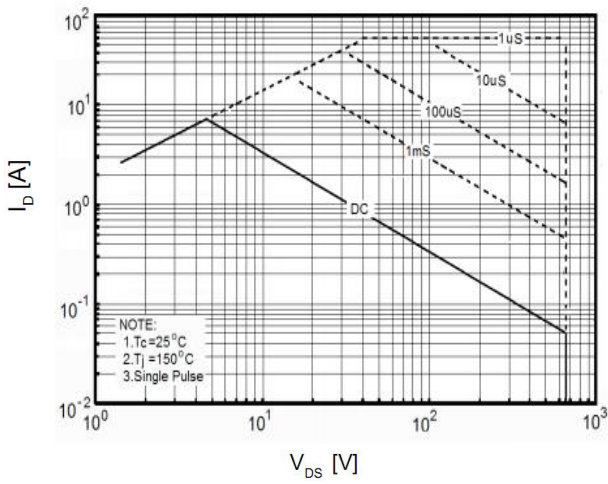

Maximum Drain Current Vs. Case Temperature

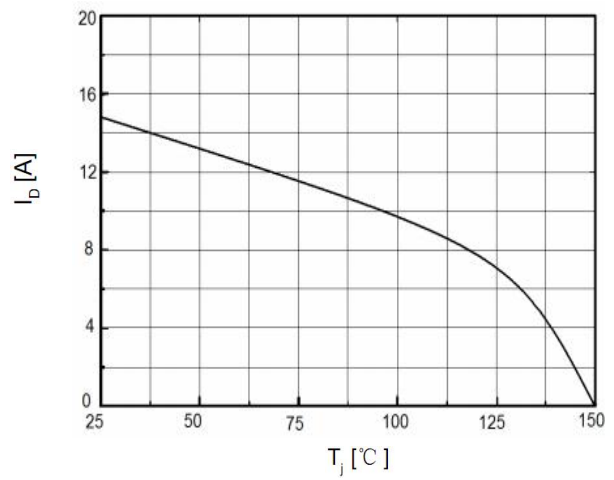

TO-220F Package Dimensions

UNIT: mm

SYMBOL	min	nom	max	SYMBOL	min	nom	max
A	9.80		10.60	D		2.54	
A1		7.00		D1	1.15		1.55
A2	2.90		3.40	D2	0.60		1.00
A3	9.10		9.90	D3	0.20		0.50
B1	15.40		16.40	E	2.24		2.84
B2	4.35		4.95	E1		0.70	
B3	6.00		7.40	E2		1.0×45°	
C	3.00		3.70	E3	0.35		0.65
C1	15.00		17.00	E4	2.30		3.30
C2	8.80		10.80	α (度)		30°	

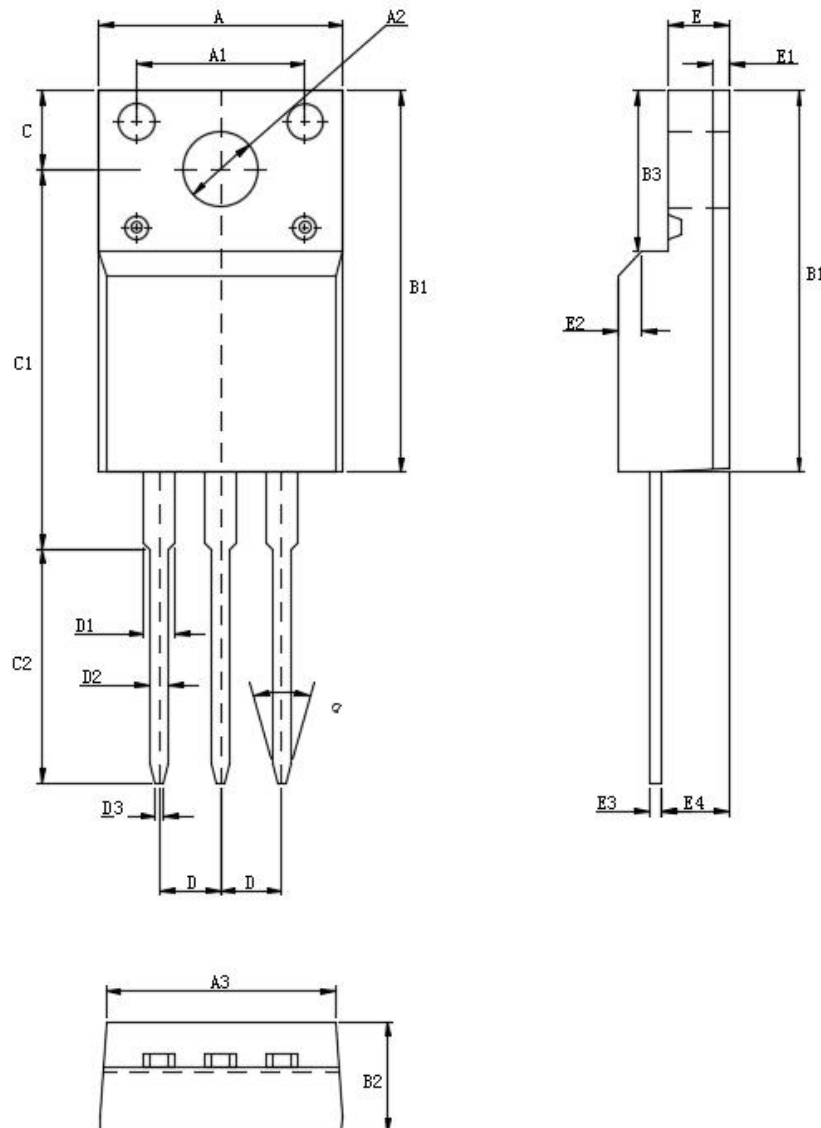



HCF65R260

650V N-Channel Super Junction Power MOSFET