



SMF7N60

600V N-Channel MOSFET

● Features:

- 7.0A, 600V, $R_{DS(on)(Typ)} = 0.95\Omega @ V_{GS}=10V$
- Low Gate Charge
- Low C_{rSS}
- 100% Avalanche Tested
- Fast Switching
- Improved dv/dt Capability

● Application:

- High Frequency Switching Mode Power Supply
- Active Power Factor Correction

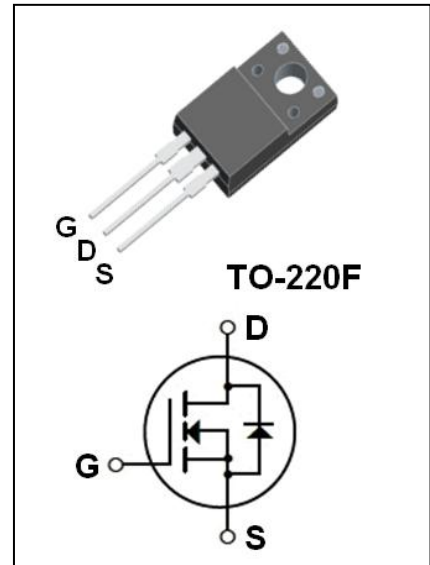

Absolute Maximum Ratings ($T_c=25^\circ C$ unless otherwise noted)

| Symbol | Parameter | Value | Unit |
|-----------|--|-------------|---------------|
| V_{DSS} | Drain-Source Voltage | 600 | V |
| I_D | Drain Current - Continuous ($T_c=25^\circ C$) - Continuous ($T_c=100^\circ C$) | 7.0* | A |
| | | 4.43* | A |
| I_{DM} | Drain Current - Pulsed (Note1) | 28* | A |
| V_{GSS} | Gate-Source Voltage | ± 30 | V |
| E_{AS} | Single Pulsed Avalanche Energy (Limit Reference Value) (Note2) | 458 | mJ |
| I_{AR} | Avalanche Current (Note1) | 7.0 | A |
| E_{AR} | Repetitive Avalanche Energy (Note1) | 12.5 | mJ |
| dv/dt | Peak Diode Recovery dv/dt (Note3) | 4.5 | V/ns |
| P_D | Power Dissipation ($T_c = 25^\circ C$) - Derate above $25^\circ C$ | 48 | W |
| | | 0.38 | W/ $^\circ C$ |
| T_j | Operating Junction Temperature | 150 | $^\circ C$ |
| T_{stg} | Storage Temperature Range | -55 to +150 | $^\circ C$ |

* Drain Current Limited by Maximum Junction Temperature.

Thermal Characteristics

| Symbol | Parameter | Max | Unit |
|-----------------|---|------|----------------|
| $R_{\theta JC}$ | Thermal Resistance, Junction to Case | 2.6 | $^\circ C / W$ |
| $R_{\theta JA}$ | Thermal Resistance, Junction to Ambient | 62.5 | $^\circ C / W$ |



SMF7N60

600V N-Channel MOSFET

Electrical Characteristics(Tc=25°C unless otherwise noted)

| Symbol | Parameter | Test Conditions | Min | Typ | Max | Unit |
|---|---|--|-----|------|------|----------|
| Off Characteristics | | | | | | |
| BV_{DSS} | Drain-source Breakdown Voltage | $V_{GS}=0V, I_D=250\mu A$ | 600 | -- | -- | V |
| $\Delta BV_{DSS} / \Delta T_J$ | Breakdown Voltage Temperature Coefficient | $I_D=250\mu A$ (Referenced to 25°C) | -- | 0.64 | -- | V/°C |
| I_{DSS} | Zero Gate Voltage Drain Current | $V_{DS}=600V, V_{GS}=0V$ | -- | -- | 1 | μA |
| | | $V_{DS}=480V, T_c=125^\circ C$ | -- | -- | 10 | μA |
| I_{GSSF} | Gate-Body Leakage Current,Forward | $V_{GS}=+30V, V_{DS}=0V$ | -- | -- | 100 | nA |
| I_{GSSR} | Gate-Body Leakage Current,Reverse | $V_{GS}=-30V, V_{DS}=0V$ | -- | -- | -100 | nA |
| On Characteristics | | | | | | |
| $V_{GS(th)}$ | Gate Threshold Voltage | $V_{DS}=V_{GS}, I_D=250\mu A$ | 2.0 | -- | 4.0 | V |
| $R_{DS(on)}$ | Static Drain-Source On-Resistance | $V_{GS}=10V, I_D=3.5A$ | -- | 0.95 | 1.2 | Ω |
| g_{FS} | Forward Transconductance | $V_{DS}=20V, I_D=3.5A$ (Note4) | -- | 7.5 | -- | S |
| Dynamic Characteristics | | | | | | |
| C_{iss} | Input Capacitance | $V_{DS}=25V, V_{GS}=0V,$ $f=1.0MHz$ | -- | 1100 | -- | pF |
| C_{oss} | Output Capacitance | | -- | 100 | -- | pF |
| C_{rss} | Reverse Transfer Capacitance | | -- | 10 | -- | pF |
| Switching Characteristics | | | | | | |
| $t_{d(on)}$ | Turn-On Delay Time | $V_{DD} = 300V, I_D = 7.0A,$ $R_G = 25\Omega$ (Note4,5) | -- | 12 | -- | ns |
| t_r | Turn-On Rise Time | | -- | 95 | -- | ns |
| $t_{d(off)}$ | Turn-Off Delay Time | | -- | 121 | -- | ns |
| t_f | Turn-Off Fall Time | | -- | 46 | -- | ns |
| Q_g | Total Gate Charge | $V_{DS} = 480V, I_D = 7.0A,$ $V_{GS} = 10V$ (Note4,5) | -- | 29 | -- | nC |
| Q_{gs} | Gate-Source Charge | | -- | 5.7 | -- | nC |
| Q_{gd} | Gate-Drain Charge | | -- | 13.8 | -- | nC |
| Drain-Source Diode Characteristics and Maximum Ratings | | | | | | |
| I_S | Maximum Continuous Drain-Source Diode Forward Current | | -- | -- | 7.0 | A |
| I_{SM} | Maximum Pulsed Drain-Source Diode Forward Current | | -- | -- | 28 | A |
| V_{SD} | Drain-Source Diode Forward Voltage | $V_{GS} = 0V, I_S = 7.0A$ | -- | -- | 1.4 | V |
| t_{rr} | Reverse Recovery Time | $V_{GS} = 0V, I_S = 7.0A,$ $dI_f/dt = 100A/\mu s$ (Note4) | -- | 312 | -- | ns |
| Q_{rr} | Reverse Recovery Charge | | -- | 2.5 | -- | μC |

Notes:

- 1、Repetitive Rating:Pulse Width Limited by Maximum Junction Temperature.
- 2、L = 17mH, $I_{AS} = 7.0A, V_{DD} = 80V, R_G = 25\Omega$, Starting $T_J = 25^\circ C$.
- 3、 $I_{SD} \leq 7.0A, di/dt \leq 200A/\mu s, V_{DD} \leq BV_{DSS}$, Starting $T_J = 25^\circ C$.
- 4、Pulse Test : Pulse Width $\leq 300\mu s$, Duty Cycle $\leq 2\%$.
- 5、Essentially Independent of Operating Temperature.



SMF7N60

600V N-Channel MOSFET

On-Regin Characteristics

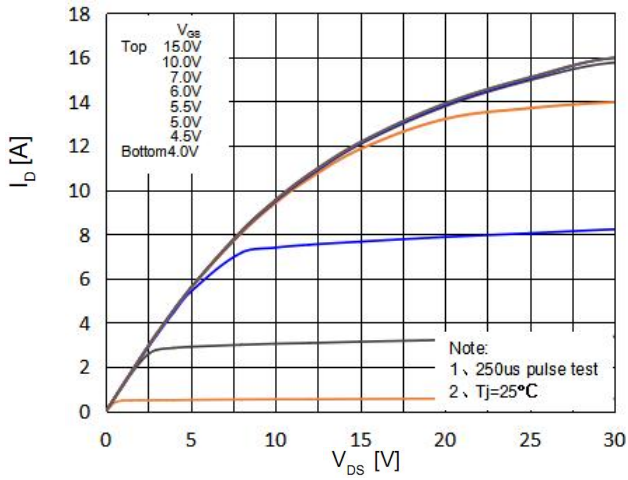

Transfer Characteristics

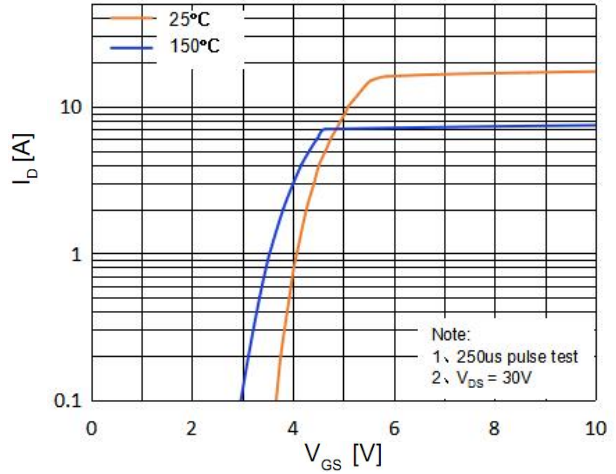

On-Resistance Variation vs. Drain Current and Gate Voltage

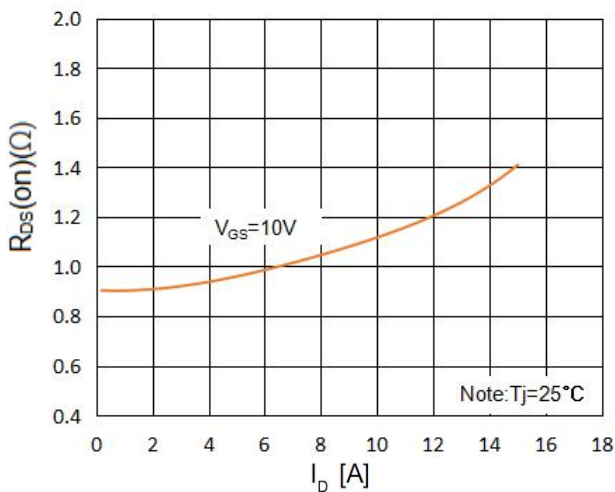

Body Diode Forward Voltage Variation vs. Source Current and Temperature

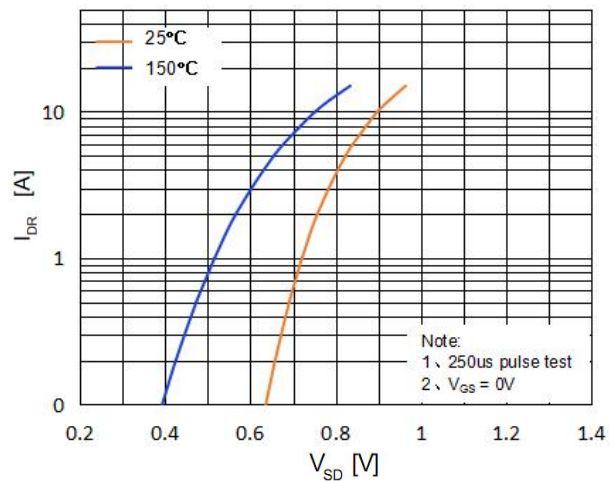

Capacitance Characteristics

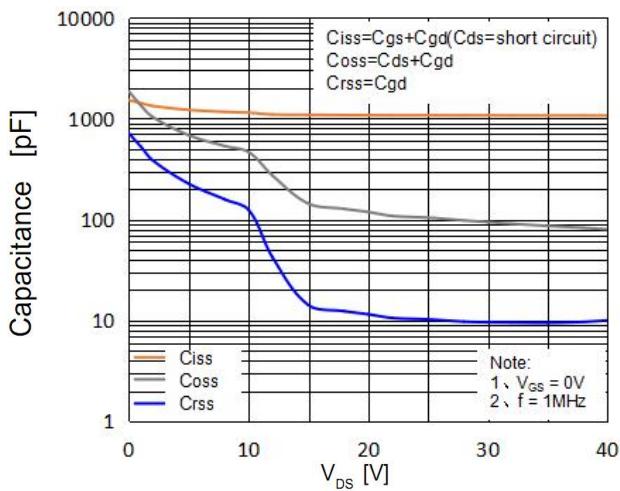

Gate Charge Characteristics

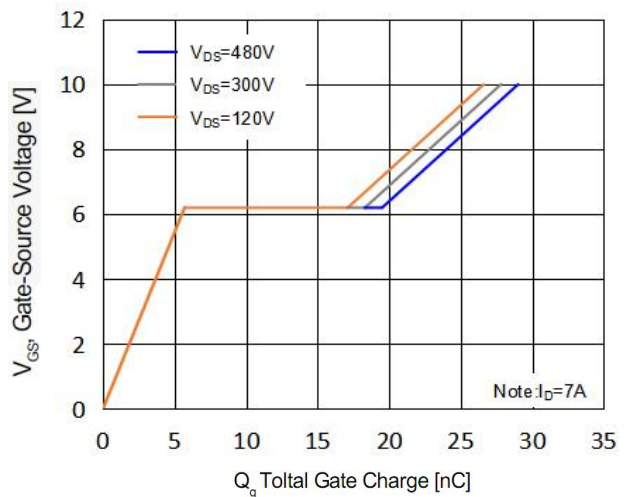



SMF7N60

600V N-Channel MOSFET

Breakdown Voltage Variation vs. Temperature

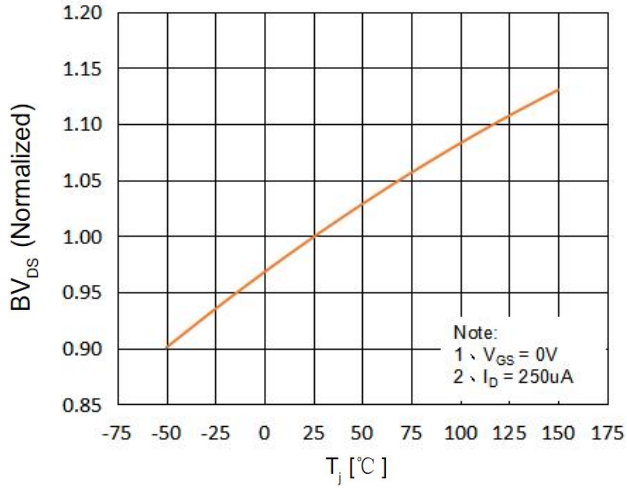

On-Resistance Variation vs. Temperature

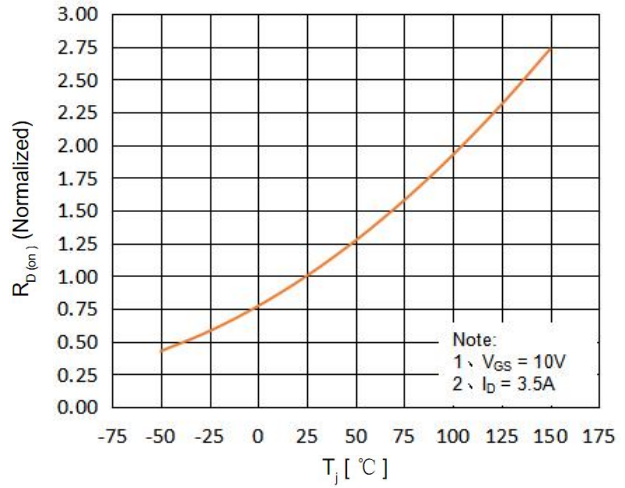

Maximum Safe Operating Area

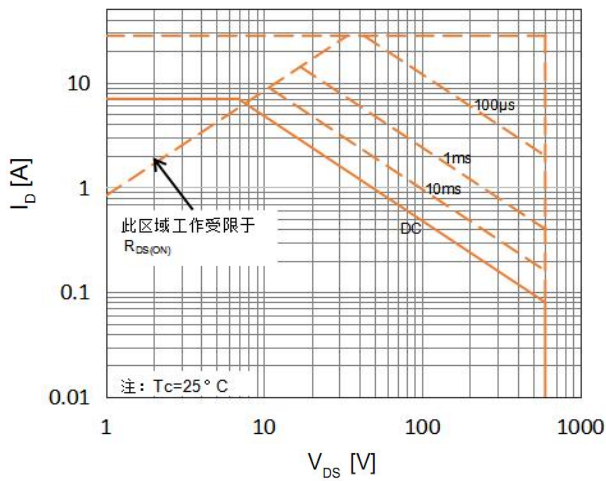

Maximum Drain Current Vs. Case Temperature

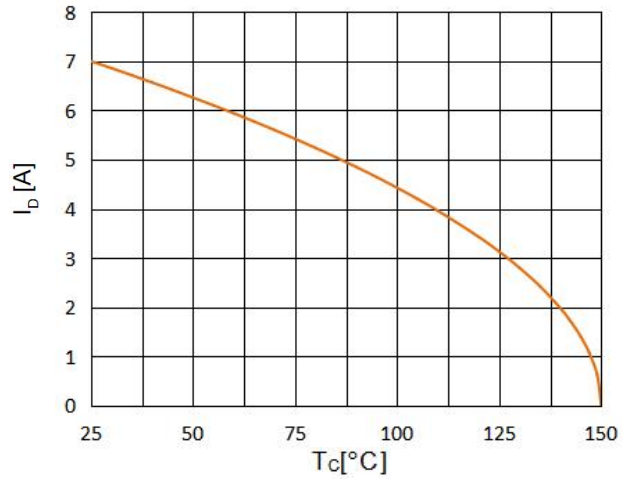



SMF7N60

600V N-Channel MOSFET

TO-220F Package Dimensions

UNIT: mm

| SYMBOL | min | nom | max | SYMBOL | min | nom | max |
|--------|-------|------|-------|--------|------|-----------|------|
| A | 9.80 | | 10.60 | D | | 2.54 | |
| A1 | | 7.00 | | D1 | 1.15 | | 1.47 |
| A2 | 2.90 | | 3.40 | D2 | 0.60 | | 0.90 |
| A3 | 9.10 | | 9.90 | D3 | 0.20 | | 0.50 |
| B1 | 15.40 | | 16.40 | E | 2.24 | | 2.84 |
| B2 | 4.35 | | 4.95 | E1 | | 0.70 | |
| B3 | 6.00 | | 7.40 | E2 | | 1.0 × 45° | |
| C | 3.00 | | 3.70 | E3 | 0.35 | | 0.65 |
| C1 | 15.00 | | 17.00 | E4 | 2.30 | | 3.30 |
| C2 | 8.80 | | 10.80 | α (度) | | 30° | |
| C3 | 2.60 | | 3.60 | | | | |

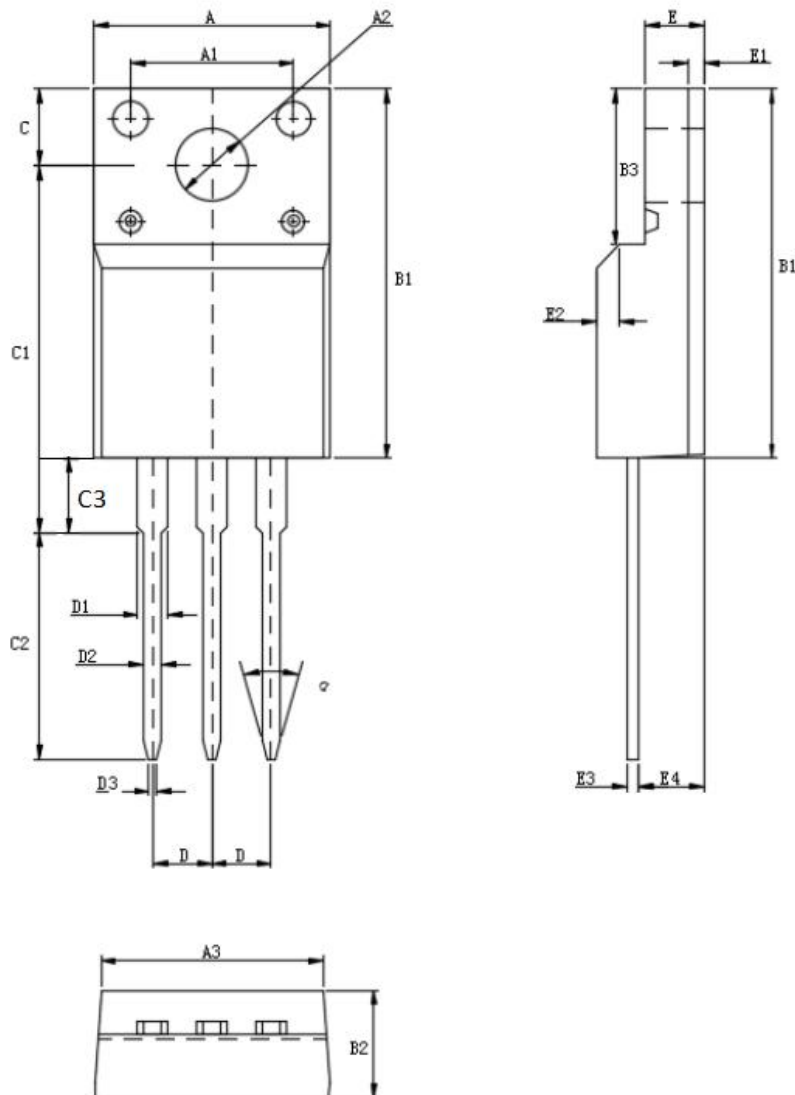



SMF7N60

600V N-Channel MOSFET

注意事项:

- 1、在电路设计时请不要超过器件的最大额定值，否则会影响整机的可靠性。
- 2、MOSFET产品为静电敏感型器件，使用时应注意采取防静电保护措施，如佩戴防静电手环、设备接地等。
- 3、如需安装散热片，请注意控制扭力大小及散热片的平整度。
- 4、该规格书由华科公司制作，并可能不定期更改，恕不另行通知。
- 5、如有疑问，请及时联系我司销售代表。

版本履历表:

| 序号 | 版本号 | 修改时间 | 修改记录 |
|----|------|------------|------|
| 1 | V1.0 | 2022-12-20 | 首次发行 |
| | | | |