



## SMD7N65-Z

650V N-Channel MOSFET

### ● Features:

- 7.0A, 650V,  $R_{DS(on)(Typ)} = 1.2\Omega @ V_{GS}=10V$
- Low Gate Charge
- Low  $C_{rSS}$
- 100% Avalanche Tested
- Fast Switching
- Improved dv/dt Capability
- Application:
- High Frequency Switching Mode Power Supply
- Active Power Factor Correction

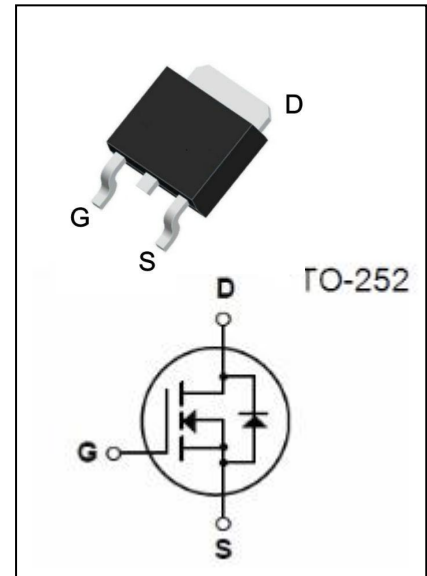

### Absolute Maximum Ratings ( $T_c=25^\circ\text{C}$ unless otherwise noted)

Symbol	Parameter	Value	Unit
$V_{DSS}$	Drain-Source Voltage	650	V
$I_D$	Drain Current - Continuous ( $T_c=25^\circ\text{C}$ ) - Continuous ( $T_c=100^\circ\text{C}$ )	7.0*	A
		4.43*	A
$I_{DM}$	Drain Current - Pulsed (Note1)	28*	A
$V_{GSS}$	Gate-Source Voltage	$\pm 30$	V
$E_{AS}$	Single Pulsed Avalanche Energy (Limit Reference Value) (Note2)	431	mJ
$I_{AR}$	Avalanche Current (Note1)	7.0	A
$E_{AR}$	Repetitive Avalanche Energy (Note1)	12.5	mJ
dv/dt	Peak Diode Recovery dv/dt (Note3)	4.5	V/ns
$P_D$	Power Dissipation ( $T_c = 25^\circ\text{C}$ ) - Derate above $25^\circ\text{C}$	100	W
		0.8	W/ $^\circ\text{C}$
$T_j$	Operating Junction Temperature	150	$^\circ\text{C}$
$T_{stg}$	Storage Temperature Range	-55 to +150	$^\circ\text{C}$

\* Drain Current Limited by Maximum Junction Temperature.

### Thermal Characteristics

Symbol	Parameter	Max	Unit
$R_{\theta JC}$	Thermal Resistance, Junction to Case	1.25	$^\circ\text{C} / \text{W}$
$R_{\theta JA}$	Thermal Resistance, Junction to Ambient	62.5	$^\circ\text{C} / \text{W}$



# SMD7N65-Z

## 650V N-Channel MOSFET

### Electrical Characteristics(Tc=25°C unless otherwise noted)

Symbol	Parameter	Test Conditions	Min	Typ	Max	Unit
<b>Off Characteristics</b>						
$BV_{DSS}$	Drain-source Breakdown Voltage	$V_{GS}=0V, I_D=250\mu A$	650	--	--	V
$\Delta BV_{DSS} / \Delta T_J$	Breakdown Voltage Temperature Coefficient	$I_D=250\mu A$ (Referenced to 25°C)	--	0.68	--	V/°C
$I_{DSS}$	Zero Gate Voltage Drain Current	$V_{DS}=650V, V_{GS}=0V$	--	--	1	$\mu A$
		$V_{DS}=520V, T_c=125^\circ C$	--	--	10	$\mu A$
$I_{GSSF}$	Gate-Body Leakage Current,Forward	$V_{GS}=+30V, V_{DS}=0V$	--	--	100	nA
$I_{GSSR}$	Gate-Body Leakage Current,Reverse	$V_{GS}=-30V, V_{DS}=0V$	--	--	-100	nA
<b>On Characteristics</b>						
$V_{GS(th)}$	Gate Threshold Voltage	$V_{DS}=V_{GS}, I_D=250\mu A$	2.0	--	4.0	V
$R_{DS(on)}$	Static Drain-Source On-Resistance	$V_{GS}=10V, I_D=3.5A$	--	1.2	1.4	$\Omega$
$g_{FS}$	Forward Transconductance	$V_{DS}=20V, I_D=3.5A$ (Note4)	--	7.7	--	S
<b>Dynamic Characteristics</b>						
$C_{iss}$	Input Capacitance	$V_{DS}=25V, V_{GS}=0V,$ $f=1.0MHz$	--	1170	--	pF
$C_{oss}$	Output Capacitance		--	87	--	pF
$C_{rss}$	Reverse Transfer Capacitance		--	5.0	--	pF
<b>Switching Characteristics</b>						
$t_{d(on)}$	Turn-On Delay Time	$V_{DD} = 325V, I_D = 7.0A,$ $R_G = 25\Omega$ (Note4,5)	--	11.5	--	ns
$t_r$	Turn-On Rise Time		--	93.8	--	ns
$t_{d(off)}$	Turn-Off Delay Time		--	118	--	ns
$t_f$	Turn-Off Fall Time		--	45.6	--	ns
$Q_g$	Total Gate Charge	$V_{DS} = 520V, I_D = 7.0A,$ $V_{GS} = 10V$ (Note4,5)	--	28.5	--	nC
$Q_{gs}$	Gate-Source Charge		--	5.9	--	nC
$Q_{gd}$	Gate-Drain Charge		--	12.8	--	nC
<b>Drain-Source Diode Characteristics and Maximum Ratings</b>						
$I_S$	Maximum Continuous Drain-Source Diode Forward Current		--	--	7.0	A
$I_{SM}$	Maximum Pulsed Drain-Source Diode Forward Current		--	--	28	A
$V_{SD}$	Drain-Source Diode Forward Voltage	$V_{GS} = 0V, I_S = 7.0A$	--	--	1.4	V
$t_{rr}$	Reverse Recovery Time	$V_{GS} = 0V, I_S = 7.0A,$ $dI_f/dt = 100A/\mu s$ (Note4)	--	309	--	ns
$Q_{rr}$	Reverse Recovery Charge		--	2.41	--	$\mu C$

Notes:

- 1、Repetitive Rating:Pulse Width Limited by Maximum Junction Temperature.
- 2、L = 16mH,  $I_{AS} = 7.0A, V_{DD} = 80V, R_G = 25\Omega$ , Starting  $T_J = 25^\circ C$ .
- 3、 $I_{SD} \leq 7.0A, di/dt \leq 200A/\mu s, V_{DD} \leq BV_{DSS}$ , Starting  $T_J = 25^\circ C$ .
- 4、Pulse Test : Pulse Width  $\leq 300\mu s$ , Duty Cycle  $\leq 2\%$ .
- 5、Essentially Independent of Operating Temperature.



# SMD7N65-Z

## 650V N-Channel MOSFET

### On-Regin Characteristics

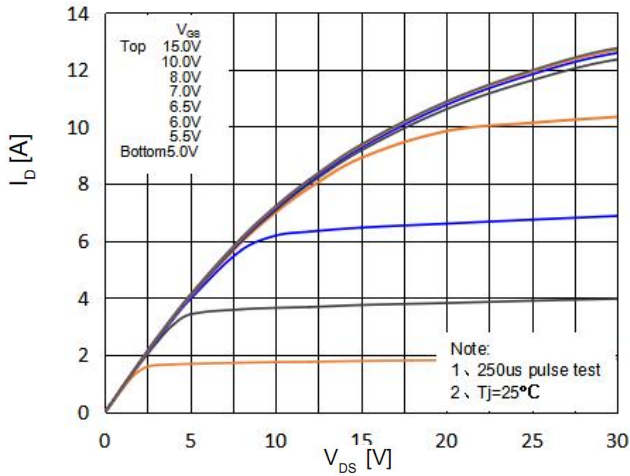

### Transfer Characteristics

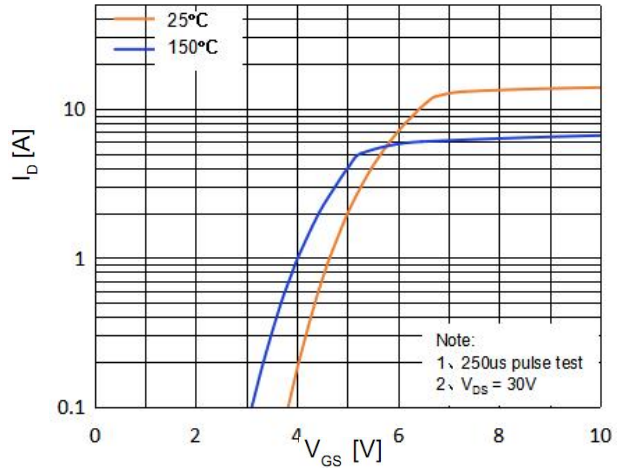

### On-Resistance Variation vs. Drain Current and Gate Voltage

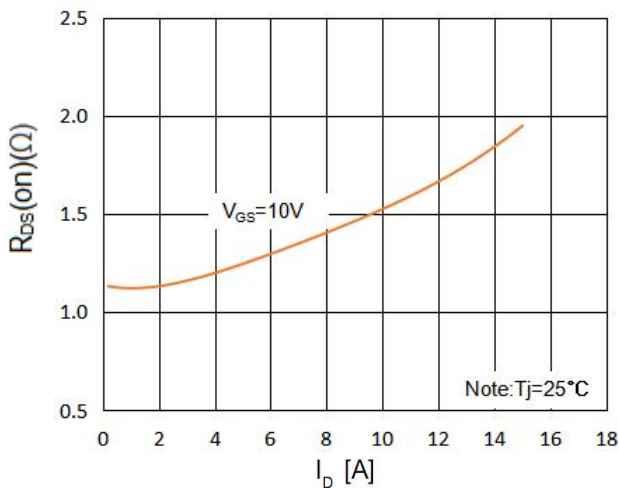

### Body Diode Forward Voltage Variation vs. Source Current and Temperature

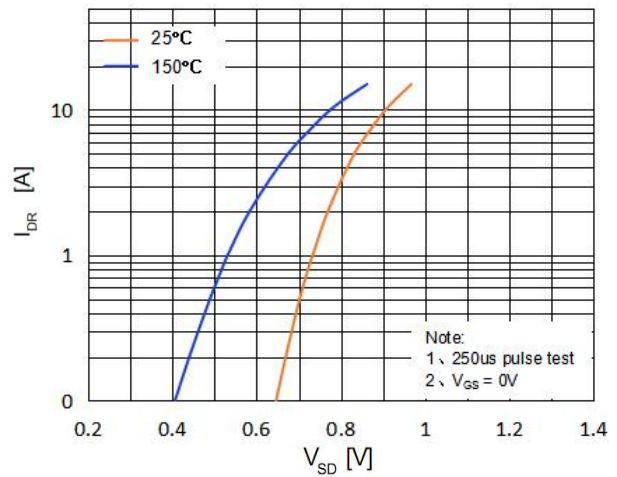

### Capacitance Characteristics

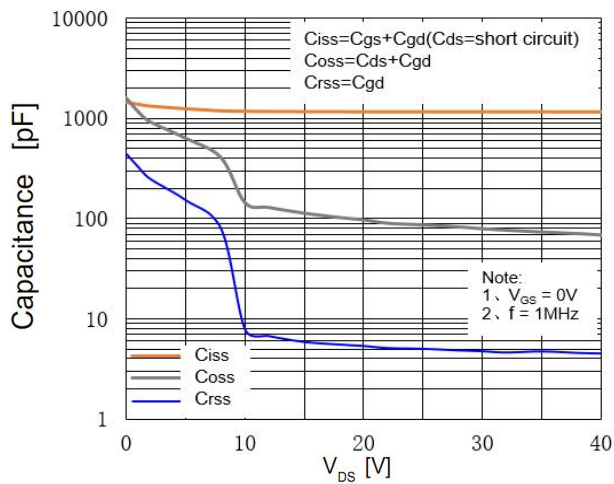

### Gate Charge Characteristics

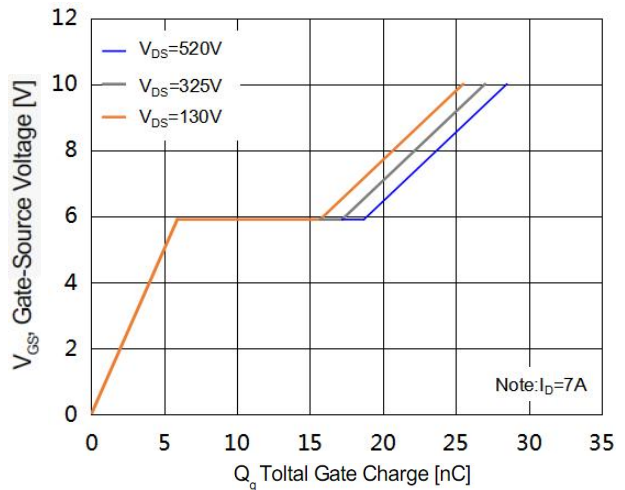



# SMD7N65-Z

## 650V N-Channel MOSFET

### Breakdown Voltage Variation vs. Temperature

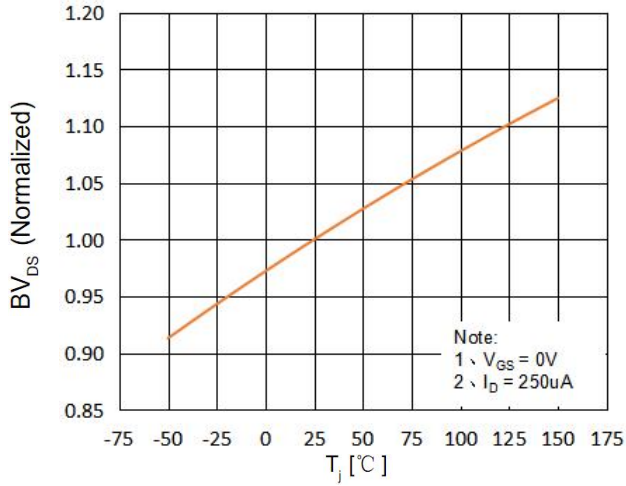

### On-Resistance Variation vs. Temperature

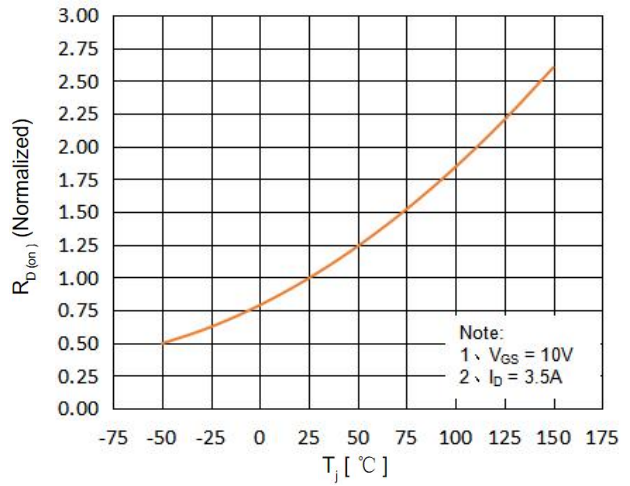

### Maximum Safe Operating Area

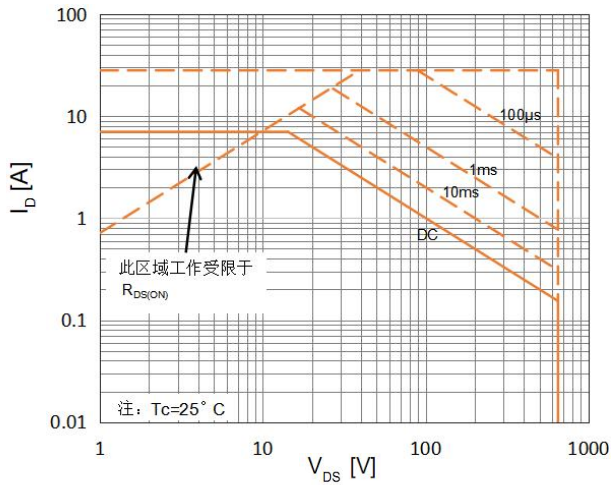

### Maximum Drain Current Vs. Case Temperature

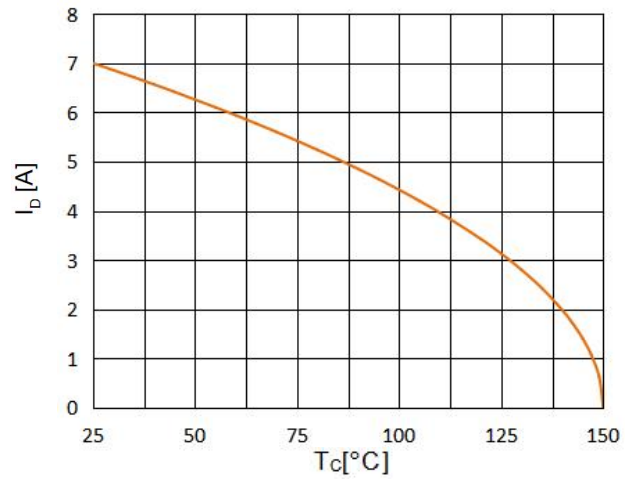



# SMD7N65-Z

650V N-Channel MOSFET

## TO-252 Package Dimensions

UNIT: mm

SYMBOL	min	nom	max	SYMBOL	min	nom	max
A	6.40		6.60	D	2.90		3.10
A1	5.20		5.40	D1	0.45		0.55
A2	4.40		4.60	D2	0.45		0.55
A3	4.40		4.60	e		2.30	
A4	0		0.15	E	2.20		2.40
A5	4.65		4.95	F	0.45		0.55
B	5.90		6.20	G		1.70	
B1	1.57		1.77	L	1.40		1.60
C	0.90		0.96	$\theta$ (度)	0		10.00

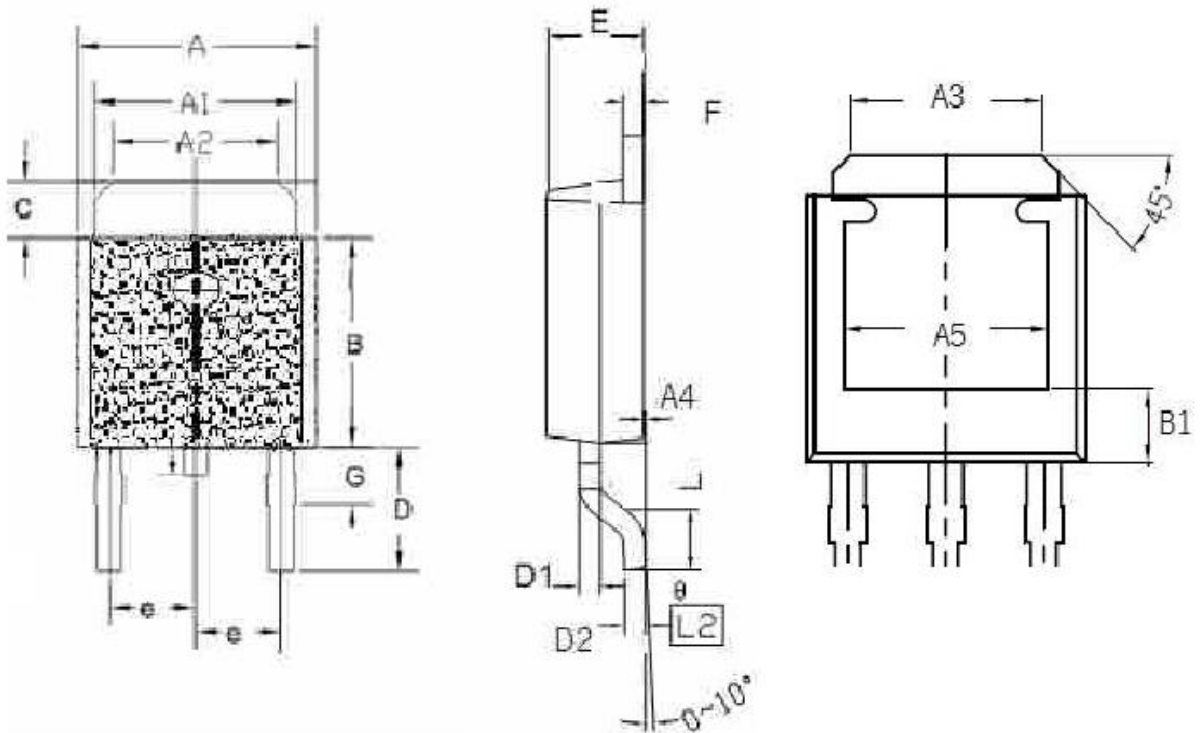



## SMD7N65-Z

650V N-Channel MOSFET

### 注意事项:

- 1、在电路设计时请不要超过器件的最大额定值，否则会影响整机的可靠性。
- 2、MOSFET产品为静电敏感型器件，使用时应注意采取防静电保护措施，如佩戴防静电手环、设备接地等。
- 3、如需安装散热片，请注意控制扭力大小及散热片的平整度。
- 4、该规格书由华科公司制作，并可能不定期更改，恕不另行通知。
- 5、如有疑问，请及时联系我司销售代表。

### 版本履历表:

序号	版本号	修改时间	修改记录
1	V1.0	2022-12-20	首次发行