



SMH13N50

500V N-Channel MOSFET

● **Features:**

- 13.0A, 500V, $R_{DS(on)(Typ)} = 380m\Omega @ V_{GS}=10V$
- Low Gate Charge
- Low C_{rSS}
- 100% Avalanche Tested
- Fast Switching
- Improved dv/dt Capability

● **Application:**

- High Frequency Switching Mode Power Supply
- Active Power Factor Correction

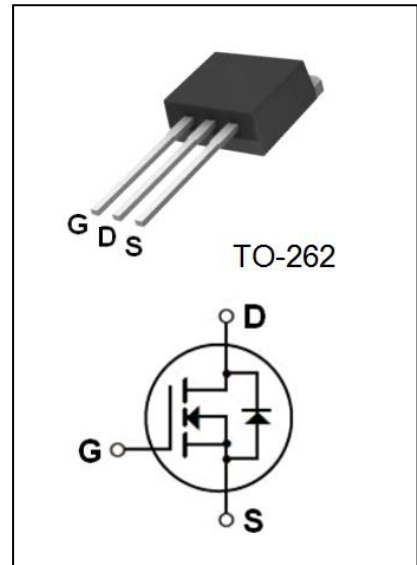

Absolute Maximum Ratings($T_c=25^\circ C$ unless otherwise noted)

Symbol	Parameter	Value	Unit
V_{DSS}	Drain-Source Voltage	500	V
I_D	Drain Current - Continuous($T_c=25^\circ C$) - Continuous($T_c=100^\circ C$)	13.0*	A
		8.2*	A
I_{DM}	Drain Current -Pulsed (Note1)	52*	A
V_{GSS}	Gate-Source Voltage	± 30	V
E_{AS}	Single Pulsed Avalanche Energy (Limit Reference Value) (Note2)	744	mJ
I_{AR}	Avalanche Current (Note1)	13.0	A
E_{AR}	Repetitive Avalanche Energy (Note1)	19.5	mJ
dv/dt	Peak Diode Recovery dv/dt (Note3)	4.5	V/ns
P_D	Power Dissipation($T_c =25^\circ C$) -Derate above $25^\circ C$	183	W
		1.46	W/ $^\circ C$
T_j	Operating Junction Temperature	150	$^\circ C$
T_{stg}	Storage Temperature Range	-55 to+150	$^\circ C$

* Drain Current Limited by Maximum Junction Temperature.

Thermal Characteristics

Symbol	Parameter	Max	Unit
$R_{\theta JC}$	Thermal Resistance,Junction to Case	0.68	$^\circ C /W$
$R_{\theta JA}$	Thermal Resistance,Junction to Ambient	62.5	$^\circ C /W$



SMH13N50

500V N-Channel MOSFET

Electrical Characteristics(Tc=25°C unless otherwise noted)

Symbol	Parameter	Test Conditions	Min	Typ	Max	Unit
Off Characteristics						
BV_{DSS}	Drain-source Breakdown Voltage	$V_{GS}=0V, I_D=250\mu A$	500	--	--	V
$\Delta BV_{DSS} / \Delta T_J$	Breakdown Voltage Temperature Coefficient	$I_D=250\mu A$ (Referenced to 25°C)	--	0.55	--	V/°C
I_{DSS}	Zero Gate Voltage Drain Current	$V_{DS}=500V, V_{GS}=0V$	--	--	1	μA
		$V_{DS}=400V, T_c=125^\circ C$	--	--	10	μA
I_{GSSF}	Gate-Body Leakage Current,Forward	$V_{GS}=+30V, V_{DS}=0V$	--	--	100	nA
I_{GSSR}	Gate-Body Leakage Current,Reverse	$V_{GS}=-30V, V_{DS}=0V$	--	--	-100	nA
On Characteristics						
$V_{GS(th)}$	Gate Threshold Voltage	$V_{DS}=V_{GS}, I_D=250\mu A$	2.0	--	4.0	V
$R_{DS(on)}$	Static Drain-Source On-Resistance	$V_{GS}=10V, I_D=6.5A$	--	380	500	m Ω
g_{FS}	Forward Transconductance	$V_{DS}=20V, I_D=6.5A$ (Note4)	--	11	--	S
Dynamic Characteristics						
C_{iss}	Input Capacitance	$V_{DS}=25V, V_{GS}=0V,$ $f=1.0MHz$	--	2000	--	pF
C_{oss}	Output Capacitance		--	190	--	pF
C_{rss}	Reverse Transfer Capacitance		--	9.5	--	pF
Switching Characteristics						
$t_{d(on)}$	Turn-On Delay Time	$V_{DD}=250V, I_D=13A,$ $R_G=25\Omega$ (Note4,5)	--	85	--	ns
t_r	Turn-On Rise Time		--	152	--	ns
$t_{d(off)}$	Turn-Off Delay Time		--	145	--	ns
t_f	Turn-Off Fall Time		--	56	--	ns
Q_g	Total Gate Charge	$V_{DS}=400V, I_D=13A,$ $V_{GS}=10V$ (Note4,5)	--	35	--	nC
Q_{gs}	Gate-Source Charge		--	10.1	--	nC
Q_{gd}	Gate-Drain Charge		--	16.7	--	nC
Drain-Source Diode Characteristics and Maximum Ratings						
I_S	Maximum Continuous Drain-Source Diode Forward Current		--	--	13	A
I_{SM}	Maximum Pulsed Drain-Source Diode Forward Current		--	--	52	A
V_{SD}	Drain-Source Diode Forward Voltage	$V_{GS}=0V, I_S=13A$	--	--	1.4	V
t_{rr}	Reverse Recovery Time	$V_{GS}=0V, I_S=13A,$ $dI_F/dt=100A/\mu s$ (Note4)	--	402	--	ns
Q_{rr}	Reverse Recovery Charge		--	4.3	--	μC

Notes:

- 1、Repetitive Rating:Pulse Width Limited by Maximum Junction Temperature.
- 2、L = 8mH, $I_{AS}=13.0A, V_{DD}=80V, R_G=25\Omega$, Starting $T_J=25^\circ C$.
- 3、 $I_{SD}\leq 13.0A, di/dt\leq 200A/\mu s, V_{DD}\leq BV_{DSS}$, Starting $T_J=25^\circ C$.
- 4、Pulse Test : Pulse Width $\leq 300\mu s$, Duty Cycle $\leq 2\%$.
- 5、Essentially Independent of Operating Temperature.



SMH13N50

500V N-Channel MOSFET

On-Regin Characteristics

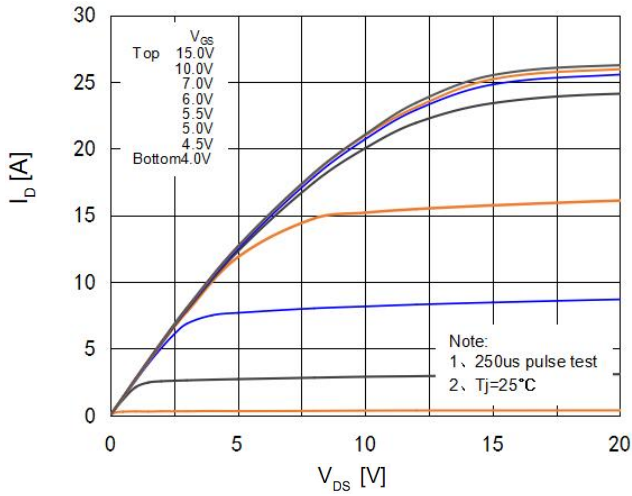

Transfer Characteristics

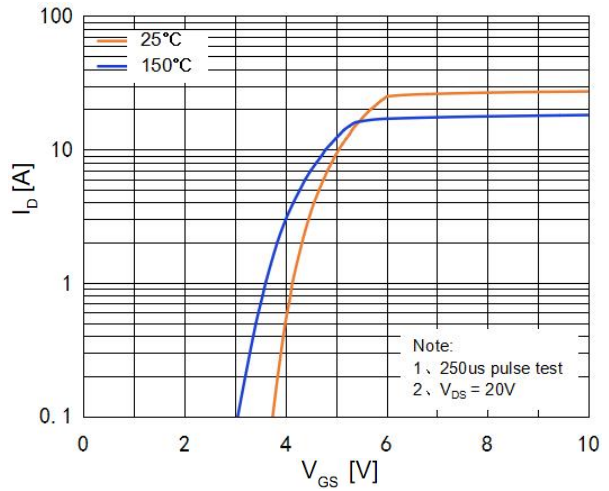

On-Resistance Variation vs. Drain Current and Gate Voltage

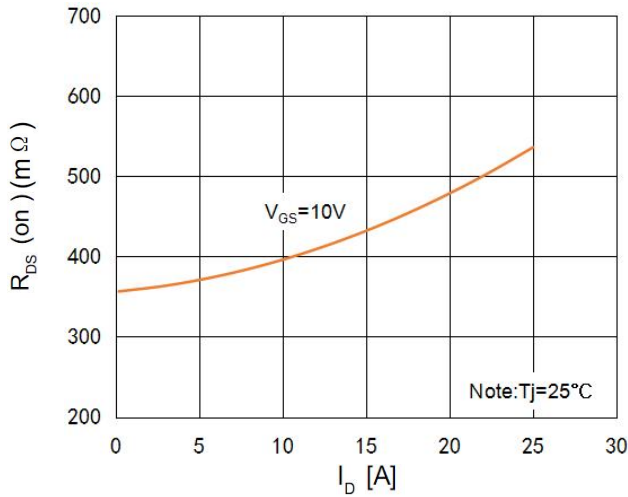

Body Diode Forward Voltage Variation vs. Source Current and Temperature

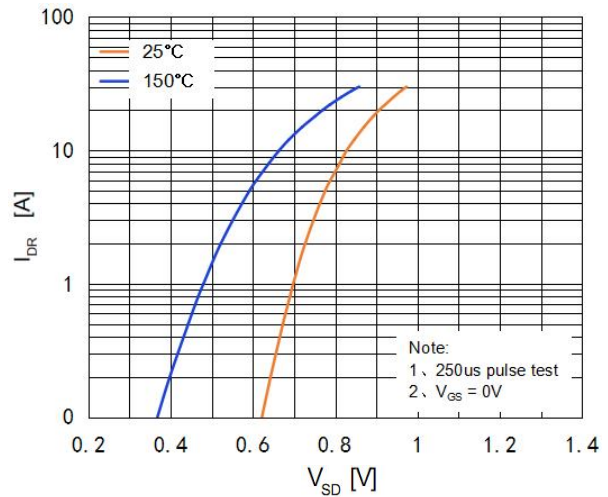

Capacitance Characteristics

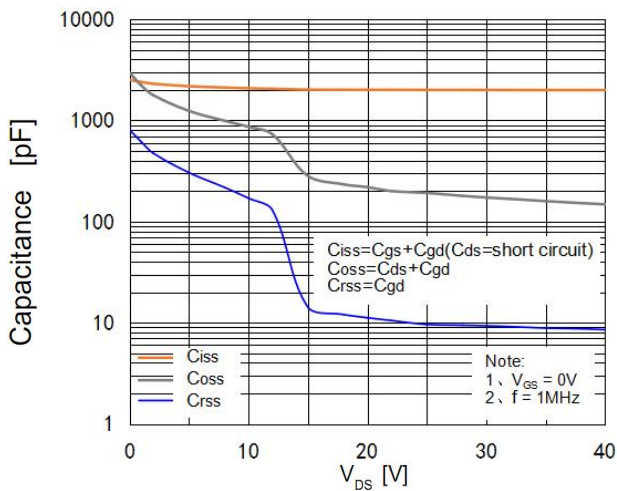

Gate Charge Characteristics

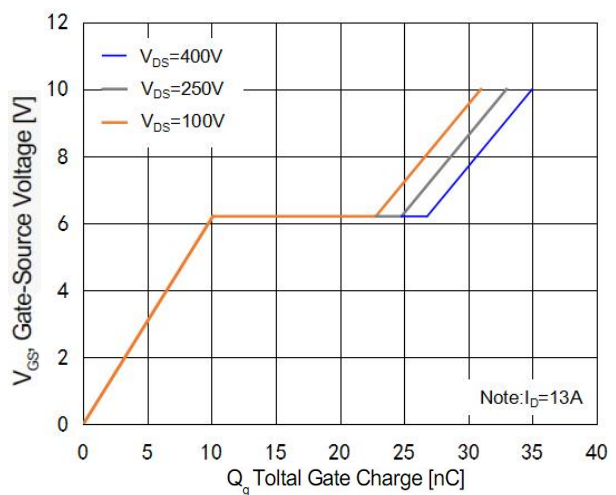



SMH13N50

500V N-Channel MOSFET

Breakdown Voltage Variation vs. Temperature

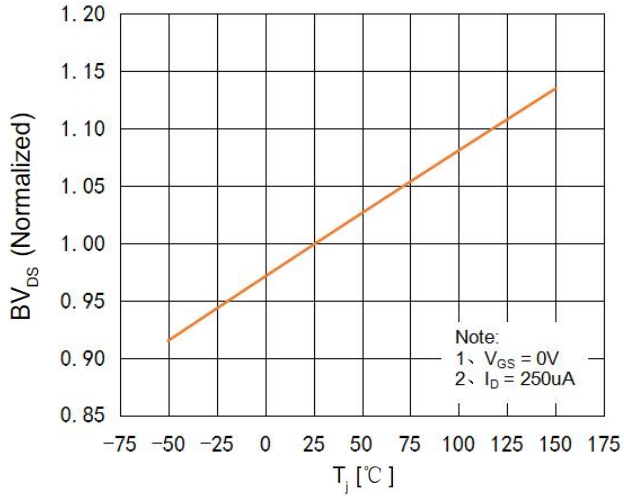

On-Resistance Variation vs. Temperature

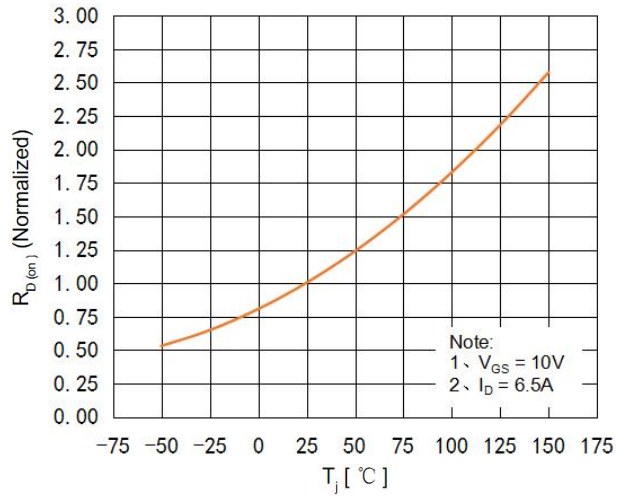

Maximum Safe Operating Area

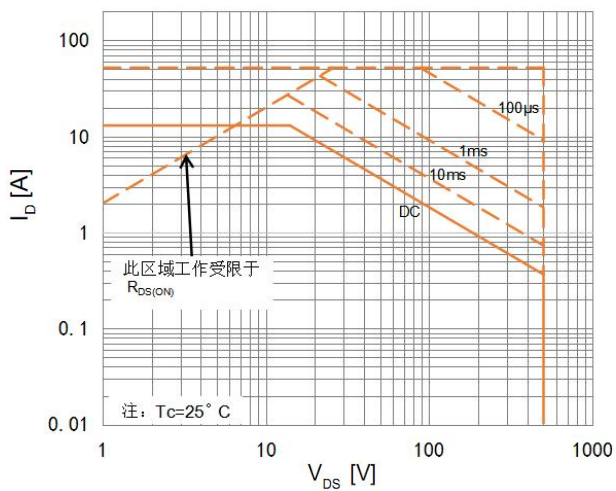

Maximum Drain Current Vs. Case Temperature

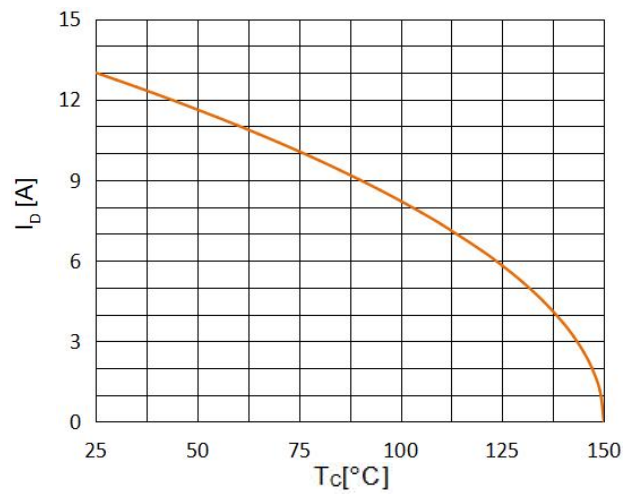



SMH13N50

500V N-Channel MOSFET

TO-262 Package Dimensions

UNIT: mm

SYMBOL	min	nom	max	SYMBOL	min	nom	max
A	4.32	4.52	4.72	D1	7.40REF		
A1	2.44	2.64	2.84	E	9.88	10.13	10.38
b	0.70	0.80	0.90	E1	7.02	8.02	9.02
b1	0.28	0.38	0.48	e	2.54REF		
b2	0.90	1.00	1.10	L	12.60	13.10	13.60
b3	1.18	1.28	1.38	L1	1.30	1.50	1.70
c	0.30	0.38	0.46	L2	2.90	3.20	3.50
c1	1.17	1.27	1.37	H	1.08	1.28	1.48
D	8.70	9.05	9.40	$\theta 1$	2°	-	7°

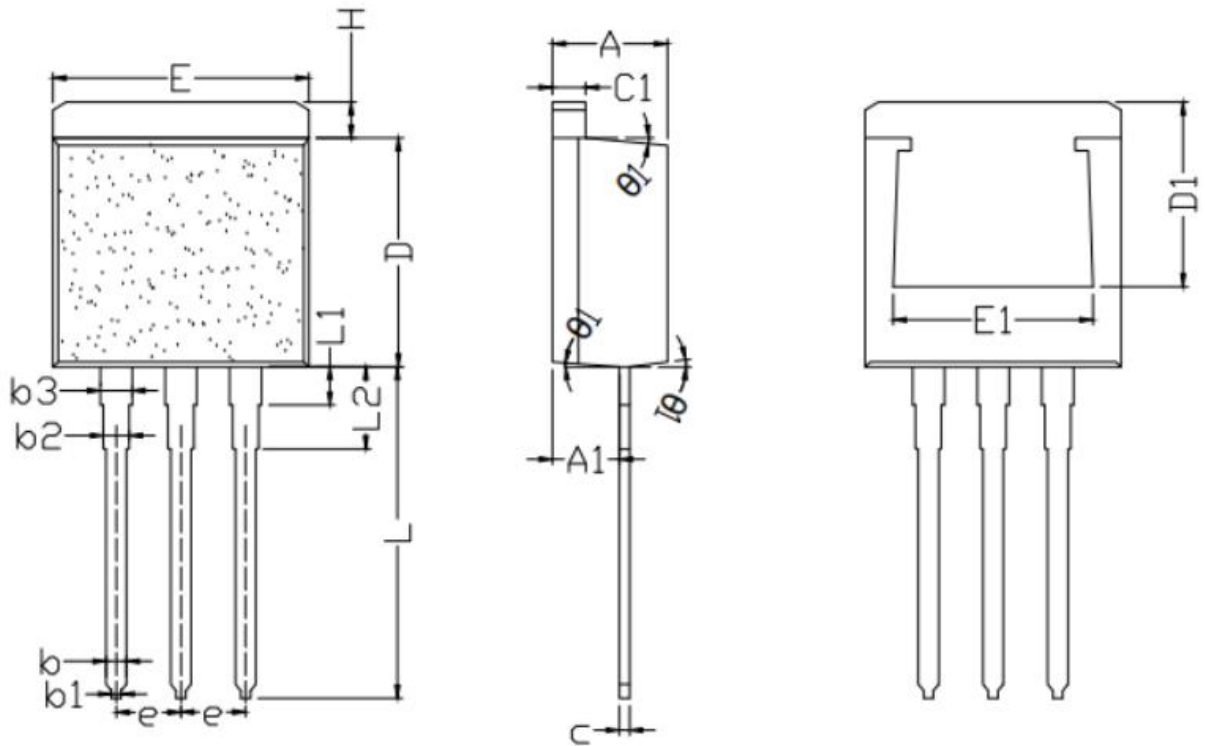



SMH13N50

500V N-Channel MOSFET

注意事项:

- 1、在电路设计时请不要超过器件的最大额定值，否则会影响整机的可靠性。
- 2、MOSFET产品为静电敏感型器件，使用时应注意采取防静电保护措施，如佩戴防静电手环、设备接地等。
- 3、如需安装散热片，请注意控制扭力大小及散热片的平整度。
- 4、该规格书由华科公司制作，并可能不定期更改，恕不另行通知。
- 5、如有疑问，请及时联系我司销售代表。

版本履历表:

序号	版本号	修改时间	修改记录
1	V1.0	2022-12-20	首次发行