



# SMF10N50-Z

## 500V N-Channel MOSFET

### ● Features:

- 10.0A, 500V,  $R_{DS(on)(Typ)} = 0.63\Omega @ V_{GS}=10V$
- Low Gate Charge
- Low  $C_{rSS}$
- 100% Avalanche Tested
- Fast Switching
- Improved dv/dt Capability

### ● Application:

- High Frequency Switching Mode Power Supply
- Active Power Factor Correction

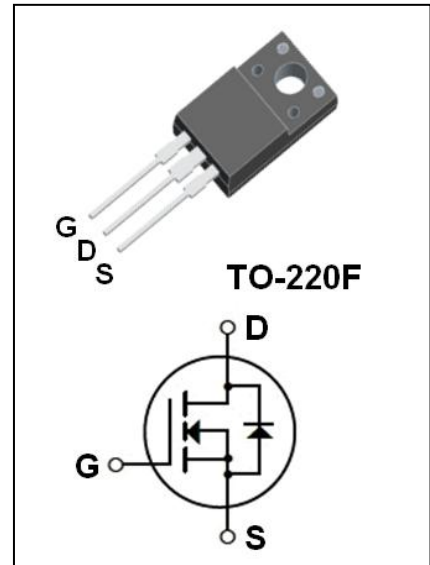

### Absolute Maximum Ratings (Tc=25°C unless otherwise noted)

Symbol	Parameter	Value	Unit
V <sub>DSS</sub>	Drain-Source Voltage	500	V
I <sub>D</sub>	Drain Current - Continuous(Tc=25°C) - Continuous(Tc=100°C)	10.0*	A
		6.3*	A
I <sub>DM</sub>	Drain Current -Pulsed (Note1)	40*	A
V <sub>GSS</sub>	Gate-Source Voltage	± 30	V
E <sub>AS</sub>	Single Pulsed Avalanche Energy ( Limit Reference Value ) (Note2)	378	mJ
I <sub>AR</sub>	Avalanche Current (Note1)	9.0	A
dv/dt	Peak Diode Recovery dv/dt (Note3)	4.5	V/ns
P <sub>D</sub>	Power Dissipation(T <sub>C</sub> =25°C) -Derate above 25°C	46	W
		0.37	W/°C
T <sub>j</sub>	Operating Junction Temperature	150	°C
T <sub>stg</sub>	Storage Temperature Range	-55 to+150	°C

\* Drain Current Limited by Maximum Junction Temperature.

### Thermal Characteristics

Symbol	Parameter	Max	Unit
R <sub>θJC</sub>	Thermal Resistance,Junction to Case	2.72	°C /W
R <sub>θJA</sub>	Thermal Resistance,Junction to Ambient	62.5	°C /W



# SMF10N50-Z

500V N-Channel MOSFET

## Electrical Characteristics(Tc=25°C unless otherwise noted)

Symbol	Parameter	Test Conditions	Min	Typ	Max	Unit
<b>Off Characteristics</b>						
BV <sub>DSS</sub>	Drain-source Breakdown Voltage	V <sub>GS</sub> =0V, I <sub>D</sub> =250μA	500	--	--	V
I <sub>DSS</sub>	Zero Gate Voltage Drain Current	V <sub>DS</sub> =500V, V <sub>GS</sub> =0V	--	--	1	μA
		V <sub>DS</sub> =400V, Tc=125°C	--	--	10	μA
I <sub>GSSF</sub>	Gate-Body Leakage Current, Forward	V <sub>GS</sub> =+30V, V <sub>DS</sub> =0V	--	--	100	nA
I <sub>GSSR</sub>	Gate-Body Leakage Current, Reverse	V <sub>GS</sub> =-30V, V <sub>DS</sub> =0V	--	--	-100	nA
<b>On Characteristics</b>						
V <sub>GS(th)</sub>	Gate Threshold Voltage	V <sub>DS</sub> = V <sub>GS</sub> , I <sub>D</sub> =250μA	2.0	--	4.0	V
R <sub>DS(on)</sub>	Static Drain-Source On-Resistance	V <sub>GS</sub> =10 V, I <sub>D</sub> =5.0A	--	0.63	0.75	Ω
g <sub>FS</sub>	Forward Transconductance	V <sub>DS</sub> =20 V, I <sub>D</sub> =5.0A (Note4)	--	9.5	--	S
<b>Dynamic Characteristics</b>						
C <sub>iss</sub>	Input Capacitance	V <sub>DS</sub> =25V, V <sub>GS</sub> =0V, f=1.0MHz	--	1370	--	pF
C <sub>oss</sub>	Output Capacitance		--	118	--	pF
C <sub>rss</sub>	Reverse Transfer Capacitance		--	6.5	--	pF
<b>Switching Characteristics</b>						
t <sub>d(on)</sub>	Turn-On Delay Time	V <sub>DD</sub> = 250 V, I <sub>D</sub> = 10.0A, R <sub>G</sub> = 25 Ω (Note4,5)	--	18	--	ns
t <sub>r</sub>	Turn-On Rise Time		--	24	--	ns
t <sub>d(off)</sub>	Turn-Off Delay Time		--	42	--	ns
t <sub>f</sub>	Turn-Off Fall Time		--	14	--	ns
Q <sub>g</sub>	Total Gate Charge	V <sub>DS</sub> = 400 V, I <sub>D</sub> =10.0A, V <sub>GS</sub> = 10 V (Note4,5)	--	30.2	--	nC
Q <sub>gs</sub>	Gate-Source Charge		--	8.6	--	nC
Q <sub>gd</sub>	Gate-Drain Charge		--	9.8	--	nC
<b>Drain-Source Diode Characteristics and Maximum Ratings</b>						
I <sub>S</sub>	Maximum Continuous Drain-Source Diode Forward Current		--	--	10	A
I <sub>SM</sub>	Maximum Pulsed Drain-Source Diode Forward Current		--	--	40	A
V <sub>SD</sub>	Drain-Source Diode Forward Voltage	V <sub>GS</sub> =0V, I <sub>S</sub> =10.0 A	--	--	1.4	V
t <sub>rr</sub>	Reverse Recovery Time	V <sub>GS</sub> =0V, I <sub>S</sub> =10.0 A, d I <sub>F</sub> /dt=100A/μs (Note4)	--	407	--	ns
Q <sub>rr</sub>	Reverse Recovery Charge		--	2.1	--	μC

Notes:

- 1、Repetitive Rating:Pulse Width Limited by Maximum Junction Temperature.
- 2、L = 8.5mH, I<sub>AS</sub> =9.0A, V<sub>DD</sub> =80V, R<sub>G</sub> = 25 Ω, Starting T<sub>J</sub> = 25°C.
- 3、I<sub>SD</sub>≤10.0A, di/dt≤200A/μs, V<sub>DD</sub>≤BV<sub>DSS</sub>, Starting T<sub>J</sub> = 25°C.
- 4、Pulse Test : Pulse Width ≤300 μ s, Duty Cycle≤2%.
- 5、Essentially Independent of Operating Temperature.



# SMF10N50-Z

## 500V N-Channel MOSFET

### On-Regin Characteristics

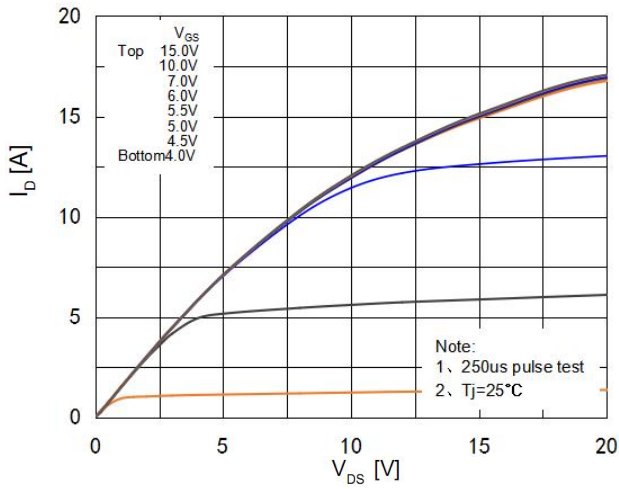

### Transfer Characteristics

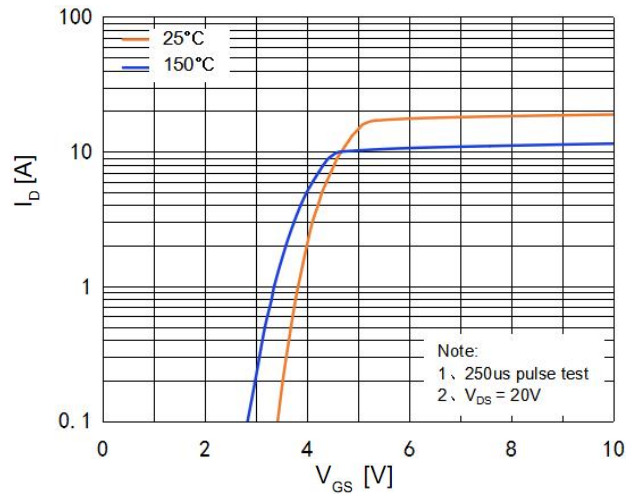

### On-Resistance Variation vs. Drain Current and Gate Voltage

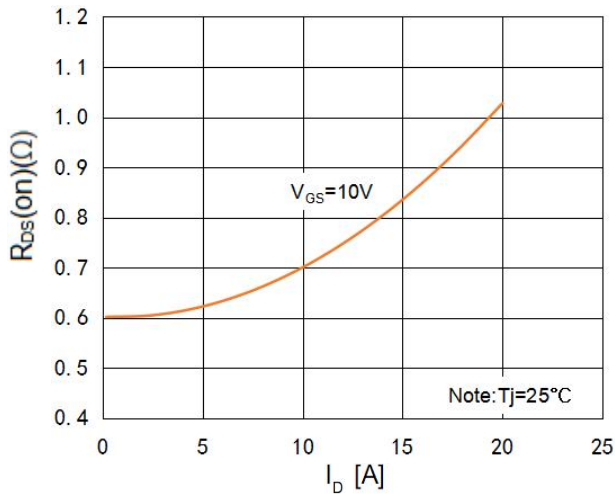

### Body Diode Forward Voltage Variation vs. Source Current and Temperature

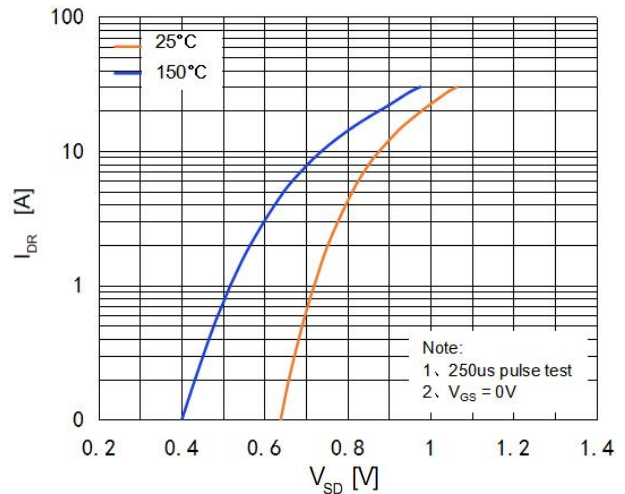

### Capacitance Characteristics

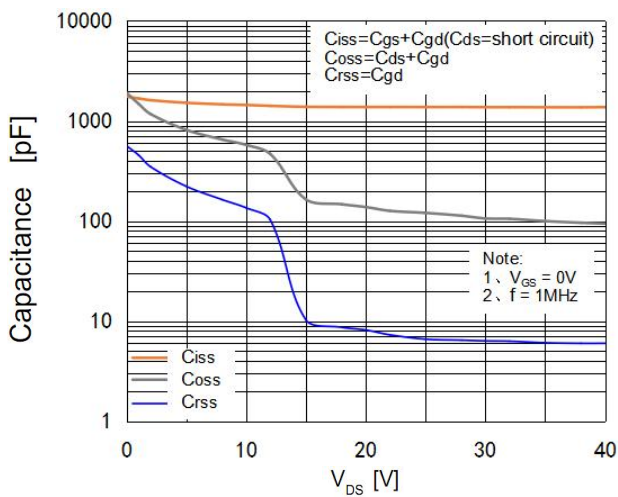

### Gate Charge Characteristics

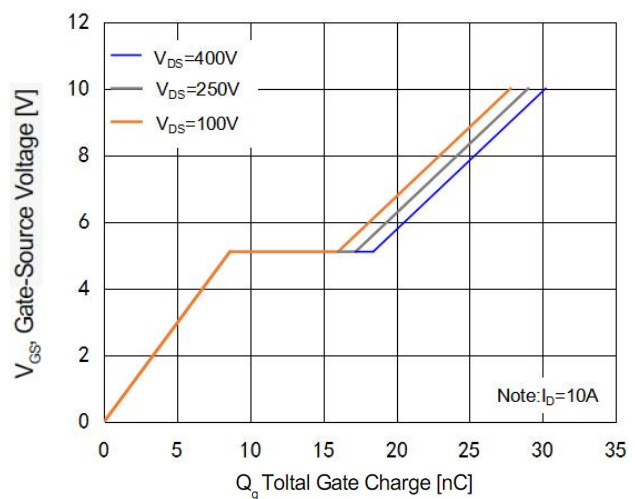

### Breakdown Voltage Variation vs. Temperature

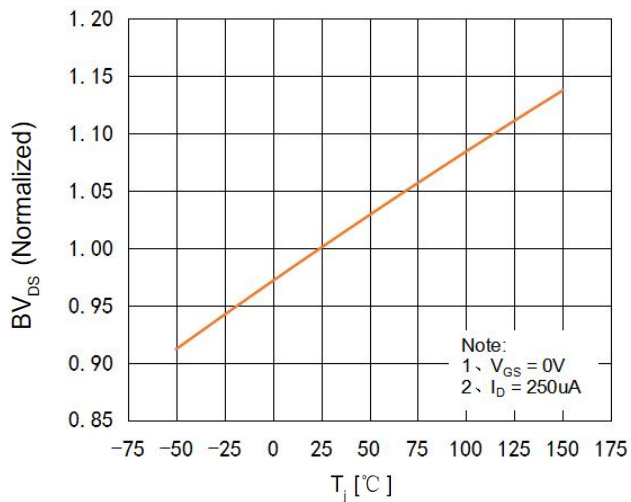

### On-Resistance Variation vs. Temperature

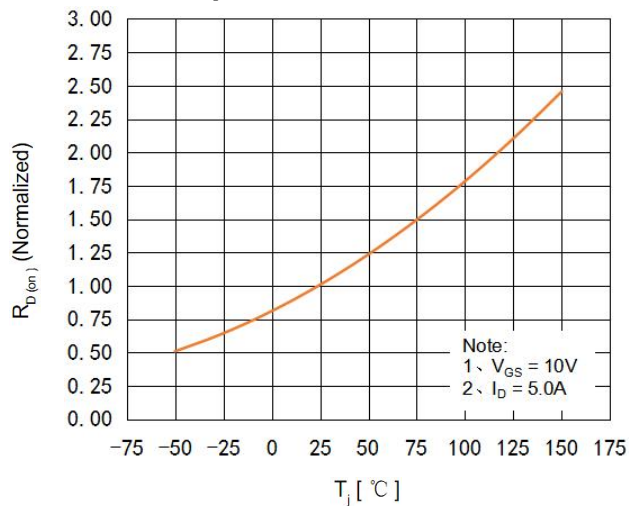

### Maximum Safe Operating Area

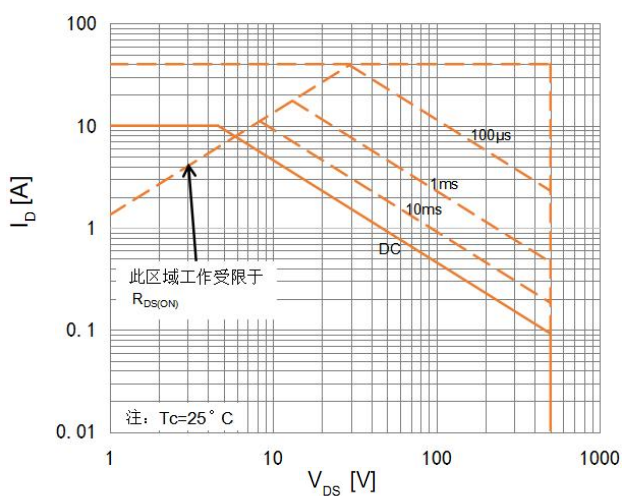

### Maximum Drain Current Vs. Case Temperature

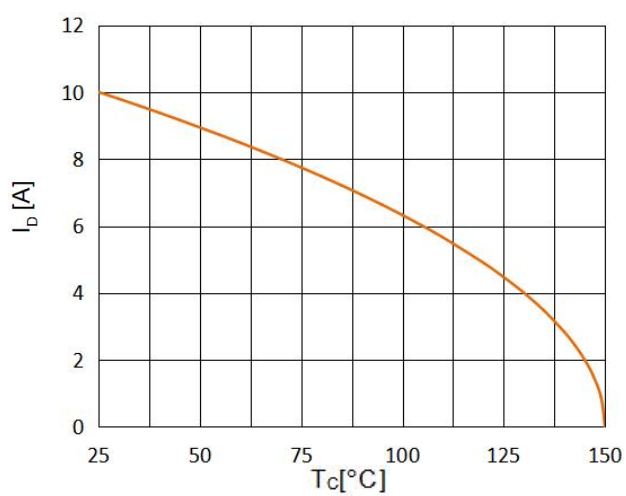

**TO-220F Package Dimensions**

UNIT: mm

SYMBOL	min	nom	max	SYMBOL	min	nom	max
A	9.80		10.60	D		2.54	
A1		7.00		D1	1.15		1.47
A2	2.90		3.40	D2	0.60		0.90
A3	9.10		9.90	D3	0.20		0.50
B1	15.40		16.40	E	2.24		2.84
B2	4.35		4.95	E1		0.70	
B3	6.00		7.40	E2		1.0 × 45°	
C	3.00		3.70	E3	0.35		0.65
C1	15.00		17.00	E4	2.30		3.30
C2	8.80		10.80	α (度)		30°	
C3	2.60		3.60				

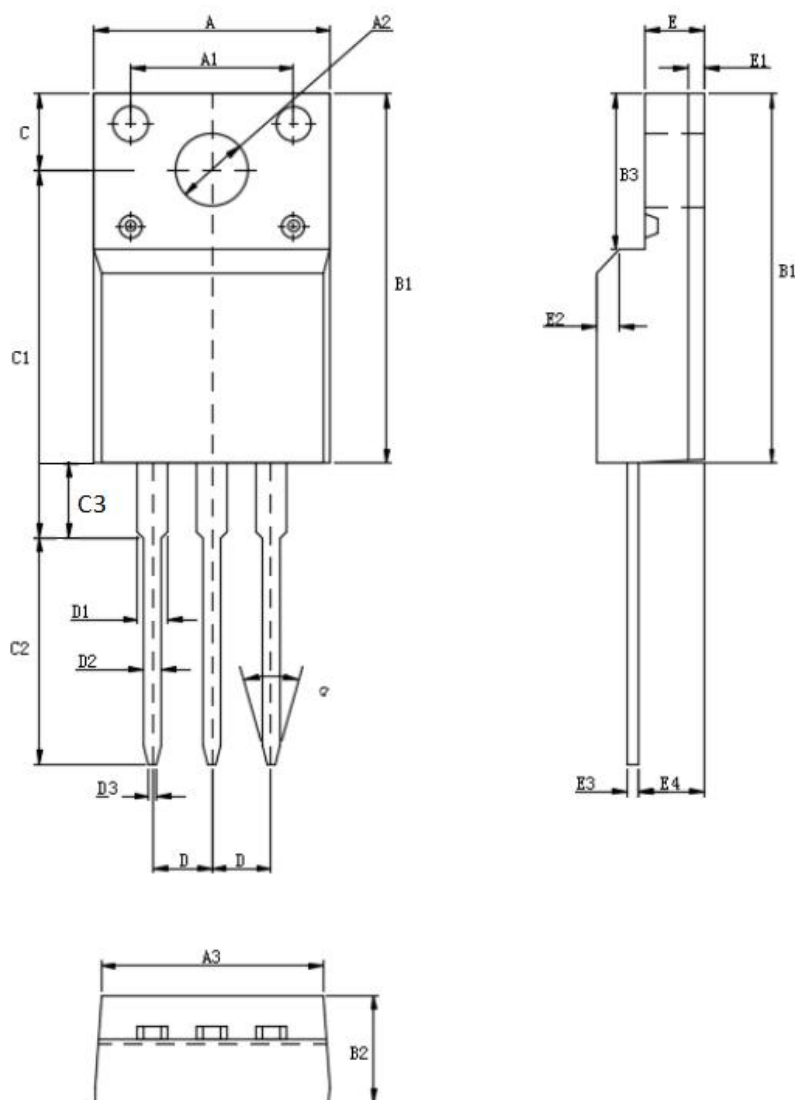



## SMF10N50-Z

500V N-Channel MOSFET

### 注意事项:

- 1、在电路设计时请不要超过器件的最大额定值，否则会影响整机的可靠性。
- 2、MOSFET产品为静电敏感型器件，使用时应注意采取防静电保护措施，如佩戴防静电手环、设备接地等。
- 3、如需安装散热片，请注意控制扭力大小及散热片的平整度。
- 4、该规格书由华科公司制作，并可能不定期更改，恕不另行通知。
- 5、如有疑问，请及时联系我司销售代表。

### 版本履历表:

序号	版本号	修改时间	修改记录
1	V1.0	2023-6-15	首次发行