



# SMF10N65-Z1

## 650V N-Channel MOSFET

### ● Features:

- 10.0A, 650V,  $R_{DS(on)(Typ)} = 0.75\Omega @ V_{GS}=10V$
- Low Gate Charge
- Low  $C_{rSS}$
- 100% Avalanche Tested
- Fast Switching
- Improved dv/dt Capability

### ● Application:

- High Frequency Switching Mode Power Supply
- Active Power Factor Correction

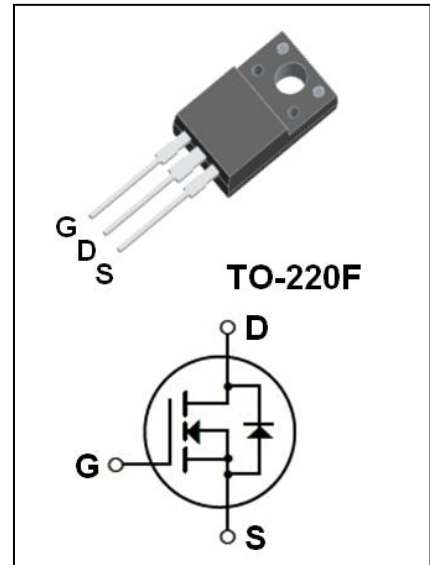

### Absolute Maximum Ratings (Tc=25°C unless otherwise noted)

Symbol	Parameter	Value	Unit
$V_{DSS}$	Drain-Source Voltage	650	V
$I_D$	Drain Current - Continuous (Tc=25°C) - Continuous (Tc=100°C)	10.0*	A
		6.3*	A
$I_{DM}$	Drain Current - Pulsed (Note1)	40*	A
$V_{GSS}$	Gate-Source Voltage	±30	V
$E_{AS}$	Single Pulsed Avalanche Energy ( Limit Reference Value ) (Note2)	632	mJ
$I_{AR}$	Avalanche Current (Note1)	10.0	A
$E_{AR}$	Repetitive Avalanche Energy (Note1)	16.8	mJ
dv/dt	Peak Diode Recovery dv/dt (Note3)	4.5	V/ns
$P_D$	Power Dissipation (Tc =25°C) -Derate above 25°C	50	W
		0.4	W/°C
$T_j$	Operating Junction Temperature	150	°C
$T_{stg}$	Storage Temperature Range	-55 to +150	°C

\* Drain Current Limited by Maximum Junction Temperature.

### Thermal Characteristics

Symbol	Parameter	Max	Unit
$R_{\theta JC}$	Thermal Resistance, Junction to Case	2.5	°C /W
$R_{\theta JA}$	Thermal Resistance, Junction to Ambient	62.5	°C /W



# SMF10N65-Z1

650V N-Channel MOSFET

## Electrical Characteristics(Tc=25°C unless otherwise noted)

Symbol	Parameter	Test Conditions	Min	Typ	Max	Unit
<b>Off Characteristics</b>						
$BV_{DSS}$	Drain-source Breakdown Voltage	$V_{GS}=0V, I_D=250\mu A$	650	--	--	V
$\Delta BV_{DSS} / \Delta T_J$	Breakdown Voltage Temperature Coefficient	$I_D=250\mu A$ (Referenced to 25°C)	--	0.68	--	V/°C
$I_{DSS}$	Zero Gate Voltage Drain Current	$V_{DS}=650V, V_{GS}=0V$	--	--	1	$\mu A$
		$V_{DS}=520V, T_c=125^\circ C$	--	--	10	$\mu A$
$I_{GSSF}$	Gate-Body Leakage Current,Forward	$V_{GS}=+30V, V_{DS}=0V$	--	--	100	nA
$I_{GSSR}$	Gate-Body Leakage Current,Reverse	$V_{GS}=-30V, V_{DS}=0V$	--	--	-100	nA
<b>On Characteristics</b>						
$V_{GS(th)}$	Gate Threshold Voltage	$V_{DS}=V_{GS}, I_D=250\mu A$	2.0	--	4.0	V
$R_{DS(on)}$	Static Drain-Source On-Resistance	$V_{GS}=10V, I_D=5.0A$	--	0.75	1.0	$\Omega$
$g_{FS}$	Forward Transconductance	$V_{DS}=20V, I_D=5.0A$ (Note4)	--	11.5	--	S
<b>Dynamic Characteristics</b>						
$C_{iss}$	Input Capacitance	$V_{DS}=25V, V_{GS}=0V,$ $f=1.0MHz$	--	1815	--	pF
$C_{oss}$	Output Capacitance		--	134	--	pF
$C_{rss}$	Reverse Transfer Capacitance		--	7.2	--	pF
<b>Switching Characteristics</b>						
$t_{d(on)}$	Turn-On Delay Time	$V_{DD} = 325V, I_D = 10A,$ $R_G = 25\Omega$ (Note4,5)	--	19.6	--	ns
$t_r$	Turn-On Rise Time		--	95	--	ns
$t_{d(off)}$	Turn-Off Delay Time		--	131	--	ns
$t_f$	Turn-Off Fall Time		--	73	--	ns
$Q_g$	Total Gate Charge	$V_{DS} = 520V, I_D = 10A,$ $V_{GS} = 10V$ (Note4,5)	--	38.5	--	nC
$Q_{gs}$	Gate-Source Charge		--	7.3	--	nC
$Q_{gd}$	Gate-Drain Charge		--	17.5	--	nC
<b>Drain-Source Diode Characteristics and Maximum Ratings</b>						
$I_S$	Maximum Continuous Drain-Source Diode Forward Current		--	--	10	A
$I_{SM}$	Maximum Pulsed Drain-Source Diode Forward Current		--	--	40	A
$V_{SD}$	Drain-Source Diode Forward Voltage	$V_{GS} = 0V, I_S = 10.0A$	--	--	1.4	V
$t_{rr}$	Reverse Recovery Time	$V_{GS} = 0V, I_S = 10.0A,$ $dI_F/dt = 100A/\mu s$ (Note4)	--	369	--	ns
$Q_{rr}$	Reverse Recovery Charge		--	3.41	--	$\mu C$

Notes:

- 1、Repetitive Rating:Pulse Width Limited by Maximum Junction Temperature.
- 2、L = 11.5mH,  $I_{AS} = 10.0A$ ,  $V_{DD} = 100V$ ,  $R_G = 25\Omega$ , Starting  $T_J = 25^\circ C$ .
- 3、 $I_{SD} \leq 10.0A$ ,  $di/dt \leq 200A/\mu s$ ,  $V_{DD} \leq BV_{DSS}$ , Starting  $T_J = 25^\circ C$ .
- 4、Pulse Test : Pulse Width  $\leq 300\mu s$ , Duty Cycle  $\leq 2\%$ .
- 5、Essentially Independent of Operating Temperature.



# SMF10N65-Z1

## 650V N-Channel MOSFET

### On-Regin Characteristics

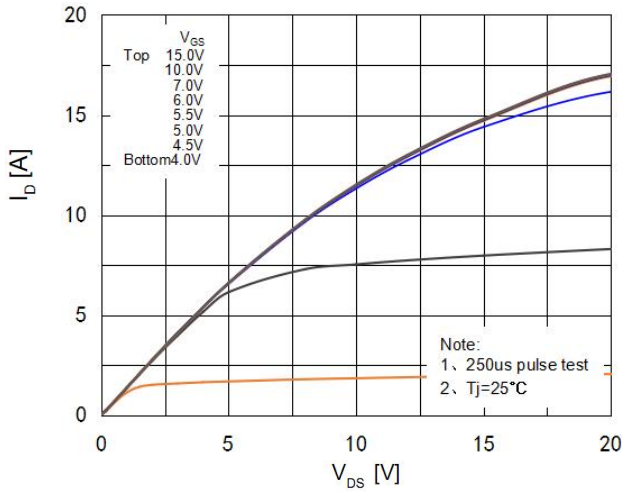

### Transfer Characteristics

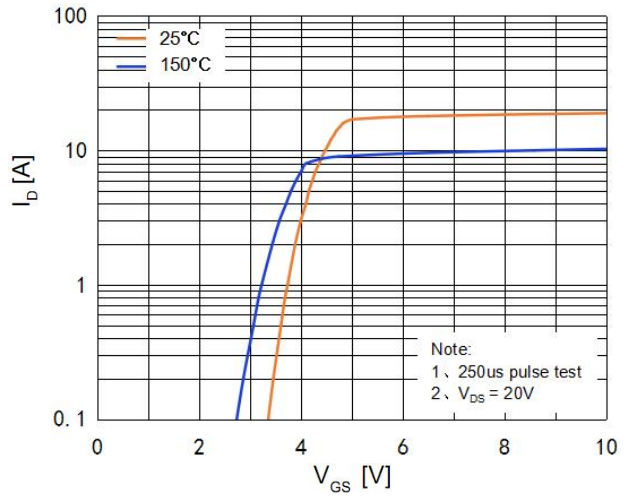

### On-Resistance Variation vs. Drain Current and Gate Voltage

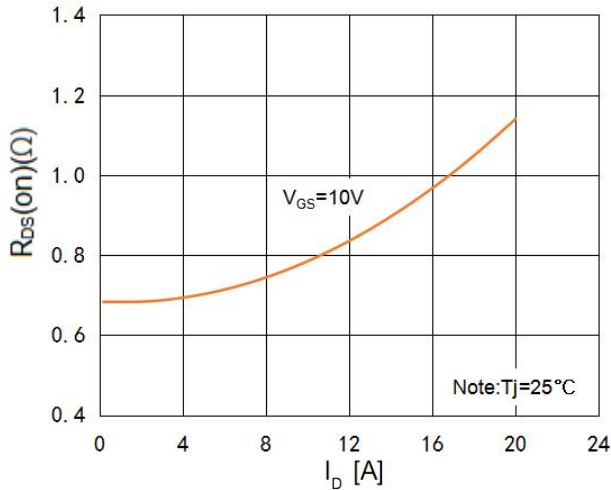

### Body Diode Forward Voltage Variation vs. Source Current and Temperature

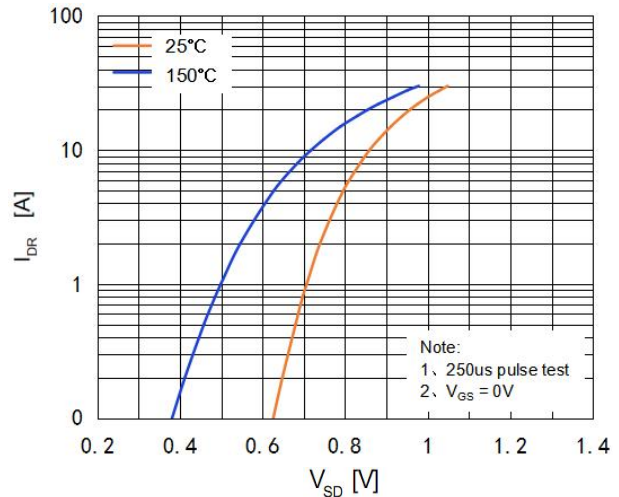

### Capacitance Characteristics

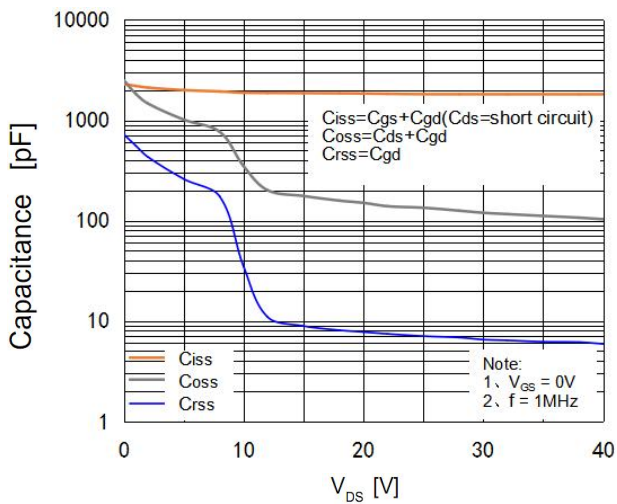

### Gate Charge Characteristics

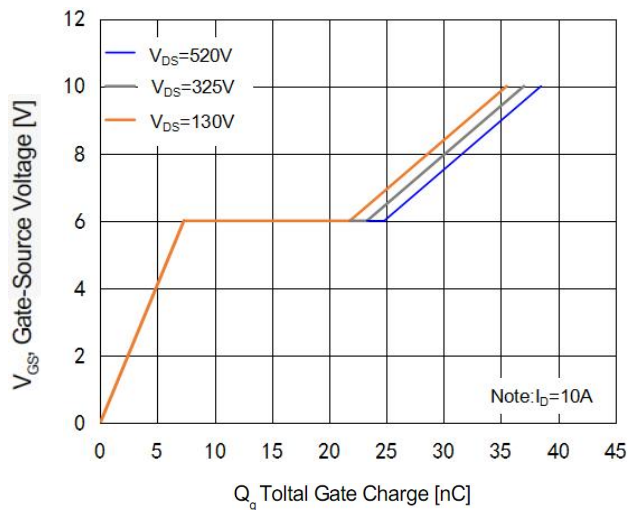



# SMF10N65-Z1

## 650V N-Channel MOSFET

### Breakdown Voltage Variation vs. Temperature

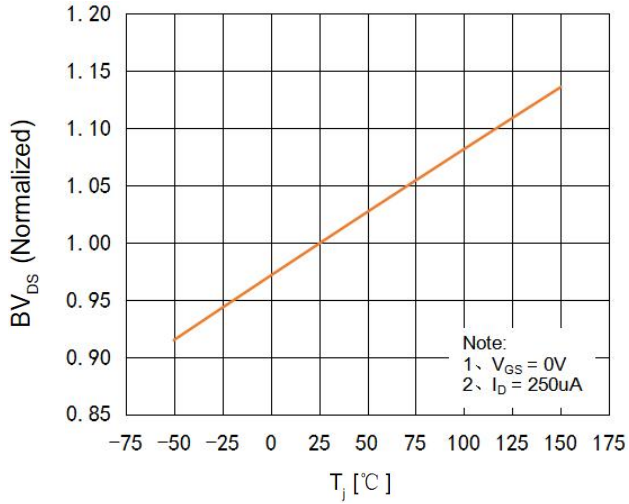

### On-Resistance Variation vs. Temperature

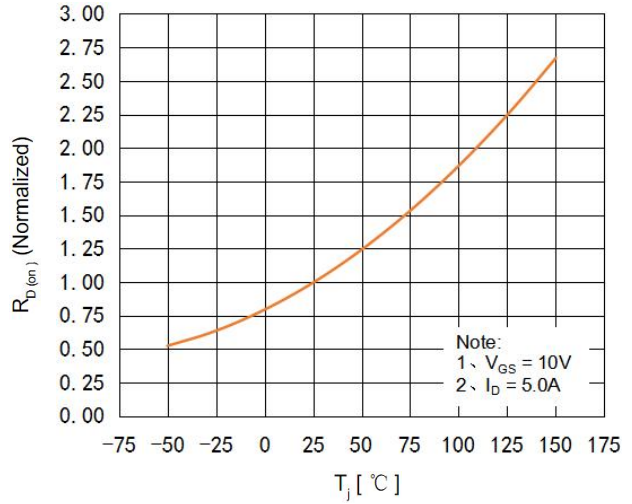

### Maximum Safe Operating Area

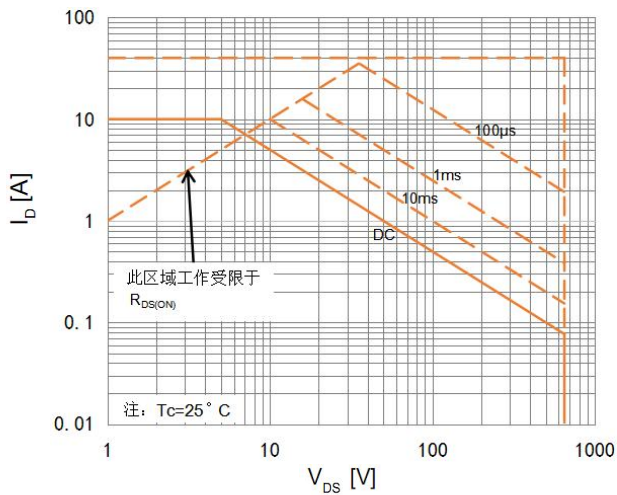

### Maximum Drain Current Vs. Case Temperature

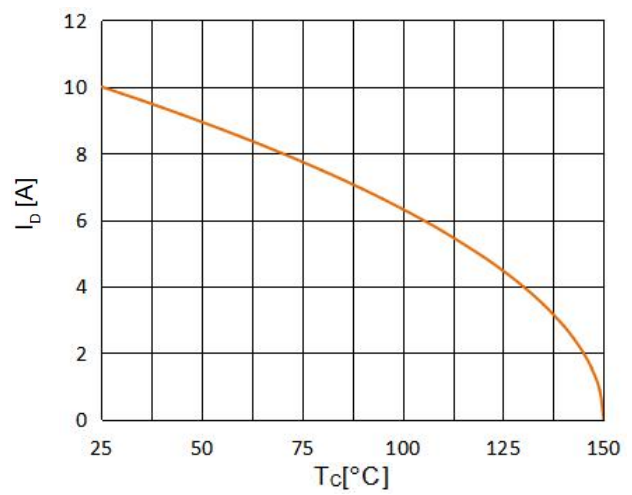

**TO-220F Package Dimensions**

UNIT: mm

SYMBOL	min	nom	max	SYMBOL	min	nom	max
A	9.80		10.60	D		2.54	
A1		7.00		D1	1.15		1.47
A2	2.90		3.40	D2	0.60		0.90
A3	9.10		9.90	D3	0.20		0.50
B1	15.40		16.40	E	2.24		2.84
B2	4.35		4.95	E1		0.70	
B3	6.00		7.40	E2		1.0 × 45°	
C	3.00		3.70	E3	0.35		0.65
C1	15.00		17.00	E4	2.30		3.30
C2	8.80		10.80	$\alpha$ (度)		30°	
C3	2.60		3.60				

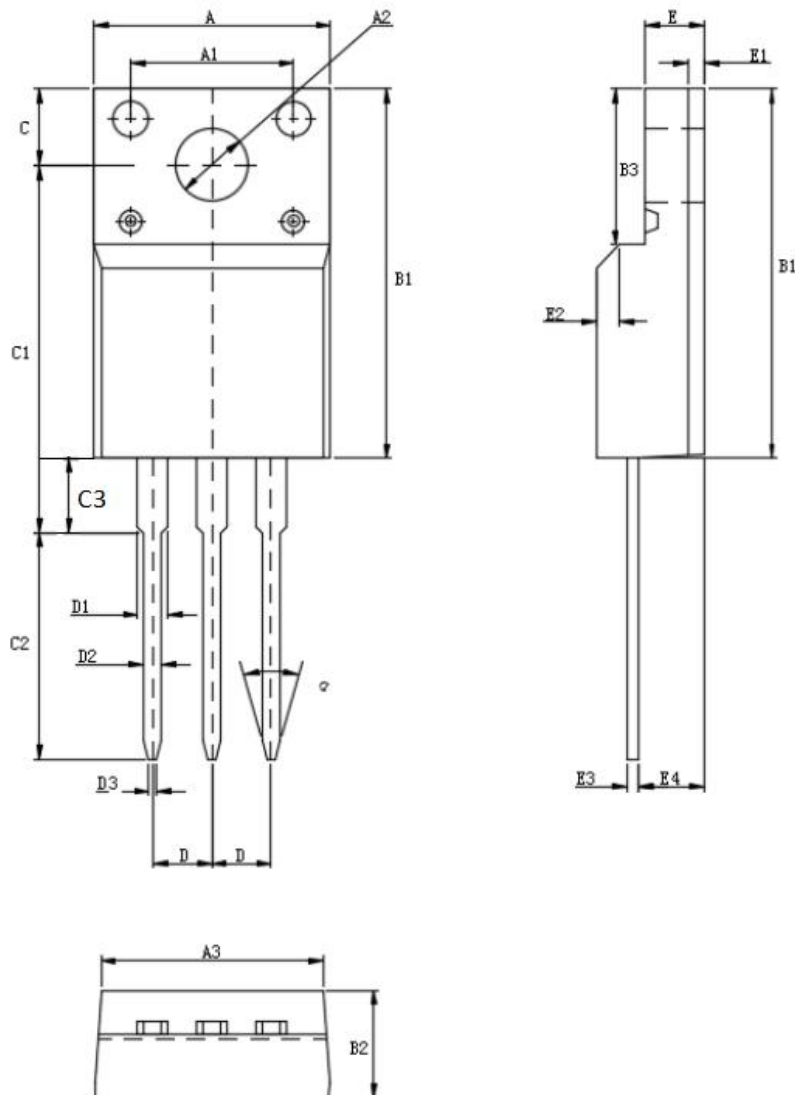



## SMF10N65-Z1

650V N-Channel MOSFET

### 注意事项:

- 1、在电路设计时请不要超过器件的最大额定值，否则会影响整机的可靠性。
- 2、MOSFET产品为静电敏感型器件，使用时应注意采取防静电保护措施，如佩戴防静电手环、设备接地等。
- 3、如需安装散热片，请注意控制扭力大小及散热片的平整度。
- 4、该规格书由华科公司制作，并可能不定期更改，恕不另行通知。
- 5、如有疑问，请及时联系我司销售代表。

### 版本履历表:

序号	版本号	修改时间	修改记录
1	V1.0	2023-9-15	首次发行