



SME13N50-U

500V N-Channel MOSFET

● Features:

- 13.0A, 500V, $R_{DS(on)(Typ)} = 380m\Omega @ V_{GS}=10V$
- Low Gate Charge
- Low C_{rSS}
- 100% Avalanche Tested
- Fast Switching
- Improved dv/dt Capability

● Application:

- High Frequency Switching Mode Power Supply
- Active Power Factor Correction

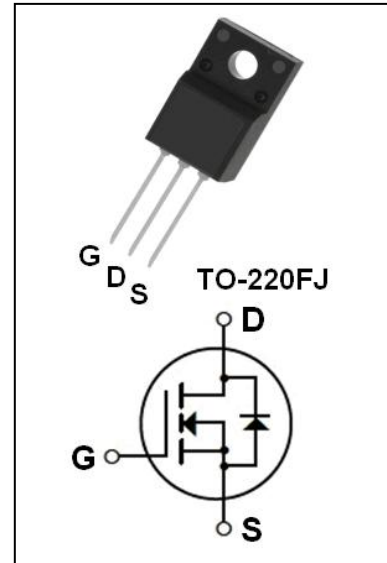

Absolute Maximum Ratings ($T_c=25^\circ\text{C}$ unless otherwise noted)

Symbol	Parameter	Value	Unit
V_{DSS}	Drain-Source Voltage	500	V
I_D	Drain Current - Continuous ($T_c=25^\circ\text{C}$) - Continuous ($T_c=100^\circ\text{C}$)	13.0*	A
		8.2*	A
I_{DM}	Drain Current - Pulsed (Note1)	52*	A
V_{GSS}	Gate-Source Voltage	± 30	V
E_{AS}	Single Pulsed Avalanche Energy (Limit Reference Value) (Note2)	744	mJ
I_{AR}	Avalanche Current (Note1)	13.0	A
E_{AR}	Repetitive Avalanche Energy (Note1)	19.5	mJ
dv/dt	Peak Diode Recovery dv/dt (Note3)	4.5	V/ns
P_D	Power Dissipation ($T_c = 25^\circ\text{C}$) - Derate above 25°C	50	W
		0.4	W/ $^\circ\text{C}$
T_j	Operating Junction Temperature	150	$^\circ\text{C}$
T_{stg}	Storage Temperature Range	-55 to +150	$^\circ\text{C}$

* Drain Current Limited by Maximum Junction Temperature.

Thermal Characteristics

Symbol	Parameter	Max	Unit
$R_{\theta JC}$	Thermal Resistance, Junction to Case	2.50	$^\circ\text{C} / \text{W}$
$R_{\theta JA}$	Thermal Resistance, Junction to Ambient	62.5	$^\circ\text{C} / \text{W}$



SME13N50-U

500V N-Channel MOSFET

Electrical Characteristics(Tc=25°C unless otherwise noted)

Symbol	Parameter	Test Conditions	Min	Typ	Max	Unit
Off Characteristics						
BV_{DSS}	Drain-source Breakdown Voltage	$V_{GS}=0V, I_D=250\mu A$	500	--	--	V
$\Delta BV_{DSS} / \Delta T_J$	Breakdown Voltage Temperature Coefficient	$I_D=250\mu A$ (Referenced to 25°C)	--	0.55	--	V/°C
I_{DSS}	Zero Gate Voltage Drain Current	$V_{DS}=500V, V_{GS}=0V$	--	--	1	μA
		$V_{DS}=400V, T_c=125^\circ C$	--	--	10	μA
I_{GSSF}	Gate-Body Leakage Current,Forward	$V_{GS}=+30V, V_{DS}=0V$	--	--	100	nA
I_{GSSR}	Gate-Body Leakage Current,Reverse	$V_{GS}=-30V, V_{DS}=0V$	--	--	-100	nA
On Characteristics						
$V_{GS(th)}$	Gate Threshold Voltage	$V_{DS}=V_{GS}, I_D=250\mu A$	2.0	--	4.0	V
$R_{DS(on)}$	Static Drain-Source On-Resistance	$V_{GS}=10V, I_D=6.5A$	--	380	500	m Ω
g_{FS}	Forward Transconductance	$V_{DS}=20V, I_D=6.5A$ (Note4)	--	11	--	S
Dynamic Characteristics						
C_{iss}	Input Capacitance	$V_{DS}=25V, V_{GS}=0V,$ $f=1.0MHz$	--	2000	--	pF
C_{oss}	Output Capacitance		--	190	--	pF
C_{rss}	Reverse Transfer Capacitance		--	9.5	--	pF
Switching Characteristics						
$t_{d(on)}$	Turn-On Delay Time	$V_{DD}=250V, I_D=13A,$ $R_G=25\Omega$ (Note4,5)	--	85	--	ns
t_r	Turn-On Rise Time		--	152	--	ns
$t_{d(off)}$	Turn-Off Delay Time		--	145	--	ns
t_f	Turn-Off Fall Time		--	56	--	ns
Q_g	Total Gate Charge	$V_{DS}=400V, I_D=13A,$ $V_{GS}=10V$ (Note4,5)	--	35	--	nC
Q_{gs}	Gate-Source Charge		--	10.1	--	nC
Q_{gd}	Gate-Drain Charge		--	16.7	--	nC
Drain-Source Diode Characteristics and Maximum Ratings						
I_S	Maximum Continuous Drain-Source Diode Forward Current		--	--	13	A
I_{SM}	Maximum Pulsed Drain-Source Diode Forward Current		--	--	52	A
V_{SD}	Drain-Source Diode Forward Voltage	$V_{GS}=0V, I_S=13A$	--	--	1.4	V
t_{rr}	Reverse Recovery Time	$V_{GS}=0V, I_S=13A,$ $dI_F/dt=100A/\mu s$ (Note4)	--	402	--	ns
Q_{rr}	Reverse Recovery Charge		--	4.3	--	μC

Notes:

- 1、Repetitive Rating:Pulse Width Limited by Maximum Junction Temperature.
- 2、L = 8mH, $I_{AS}=13.0A, V_{DD}=80V, R_G=25\Omega$, Starting $T_J=25^\circ C$.
- 3、 $I_{SD}\leq 13.0A, di/dt\leq 200A/\mu s, V_{DD}\leq BV_{DSS}$, Starting $T_J=25^\circ C$.
- 4、Pulse Test : Pulse Width $\leq 300\mu s$, Duty Cycle $\leq 2\%$.
- 5、Essentially Independent of Operating Temperature.



SME13N50-U

500V N-Channel MOSFET

On-Regin Characteristics

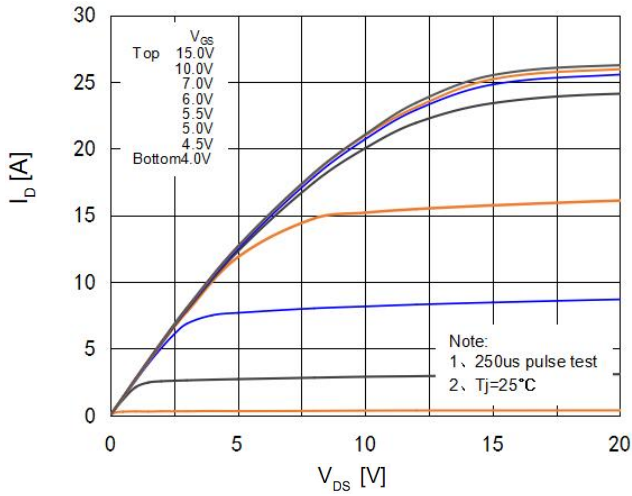

Transfer Characteristics

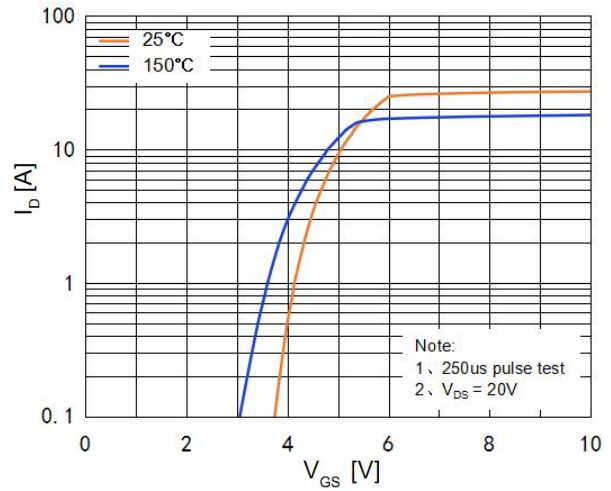

On-Resistance Variation vs. Drain Current and Gate Voltage

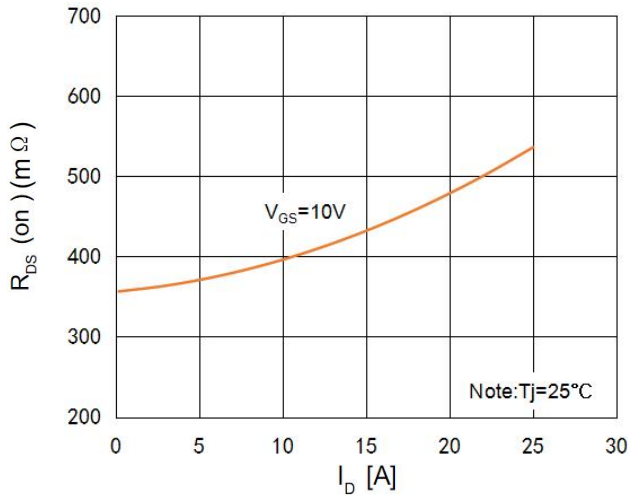

Body Diode Forward Voltage Variation vs. Source Current and Temperature

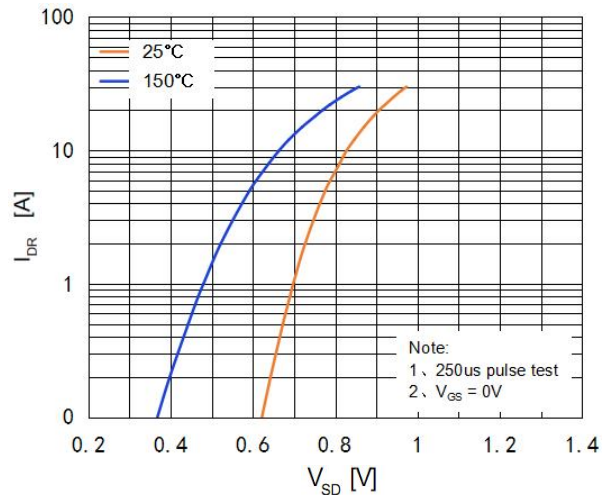

Capacitance Characteristics

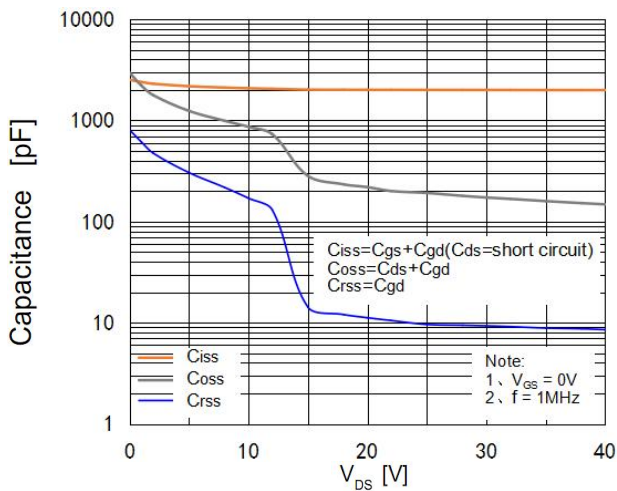

Gate Charge Characteristics

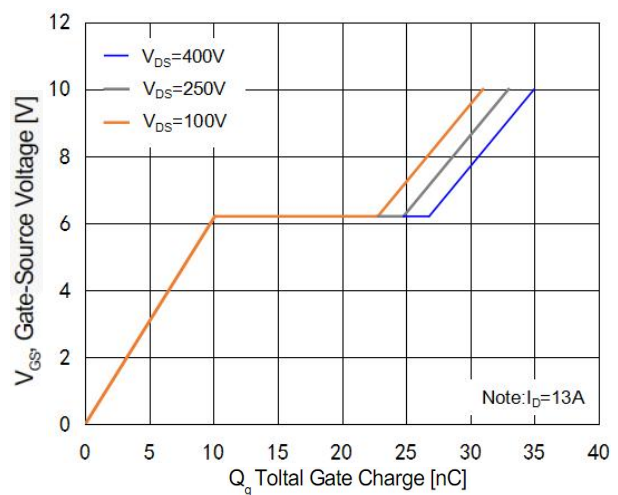

Breakdown Voltage Variation vs. Temperature

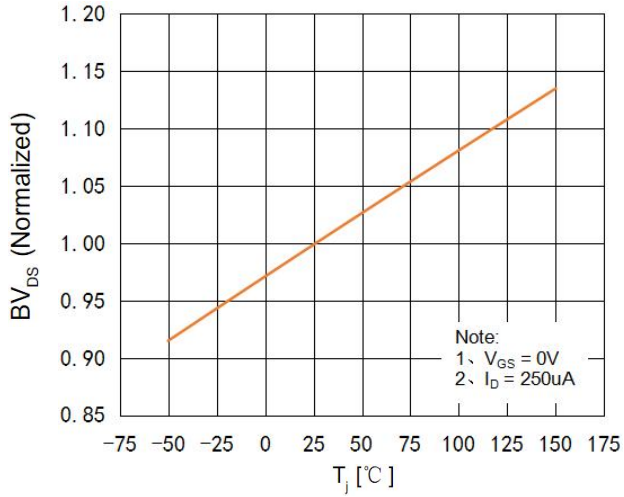

On-Resistance Variation vs. Temperature

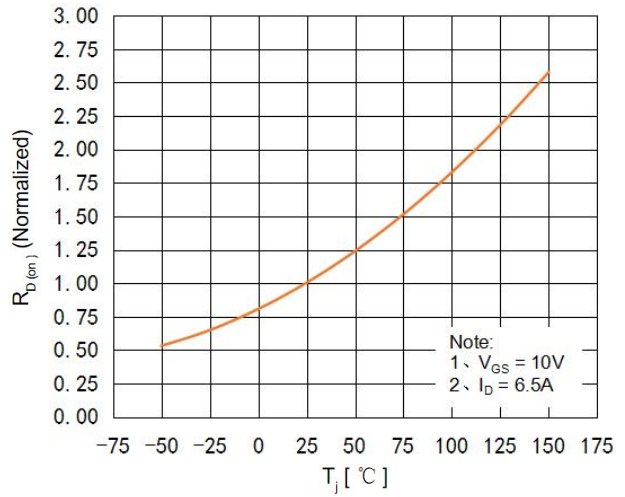

Maximum Safe Operating Area

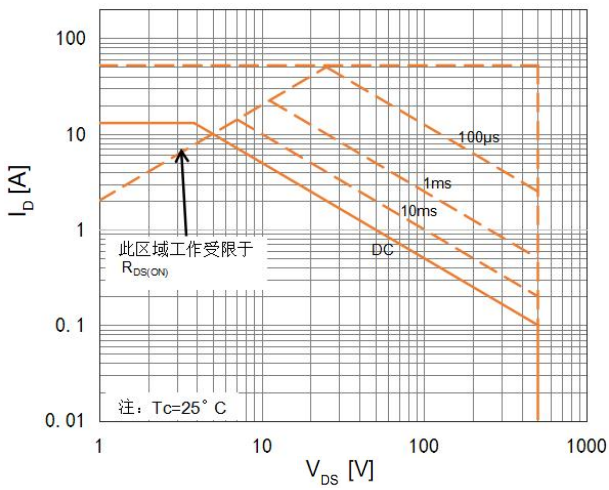

Maximum Drain Current Vs. Case Temperature

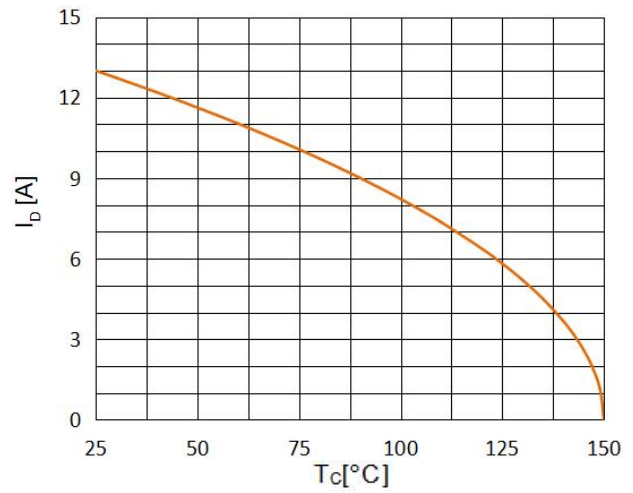



SME13N50-U

500V N-Channel MOSFET

TO-220FJ (窄脚) Package Dimensions

UNIT: mm

SYMBOL	min	nom	max	SYMBOL	min	nom	max
A	4.50	4.70	4.90	F3	3.10	3.30	3.50
A1	2.34	2.54	2.74	F4	3.70	3.90	4.10
A2	2.56	2.76	2.93	G1	6.80	7.00	7.20
A3	1.0REF			K1	0.60	0.70	0.80
b	0.60	0.70	0.80	L	11.98	12.98	13.98
b1	0.90	1.00	1.10	L1	-	-	0.95
c	0.40	0.50	0.60	Q	6.50REF		
D	15.47	15.87	16.27	ΦP	2.98	3.18	3.38
D1	12.17	12.57	12.97	ΦP1	3.20	3.40	3.60
e	2.54REF			ΦP2	1.30	1.50	1.70
e1	5.08REF			ΦP3	0.80	1.00	1.20
E	9.86	10.16	10.46	θ 1	3°	5°	7°
E1	9.76	10.06	10.36	θ 2	40°	45°	50°
E2	9.10	9.40	9.70	θ 3	3°	5°	7°
F1	1.30	1.50	1.70	DEF	0.05	0.10	0.20
F2	13.60	13.90	14.20				

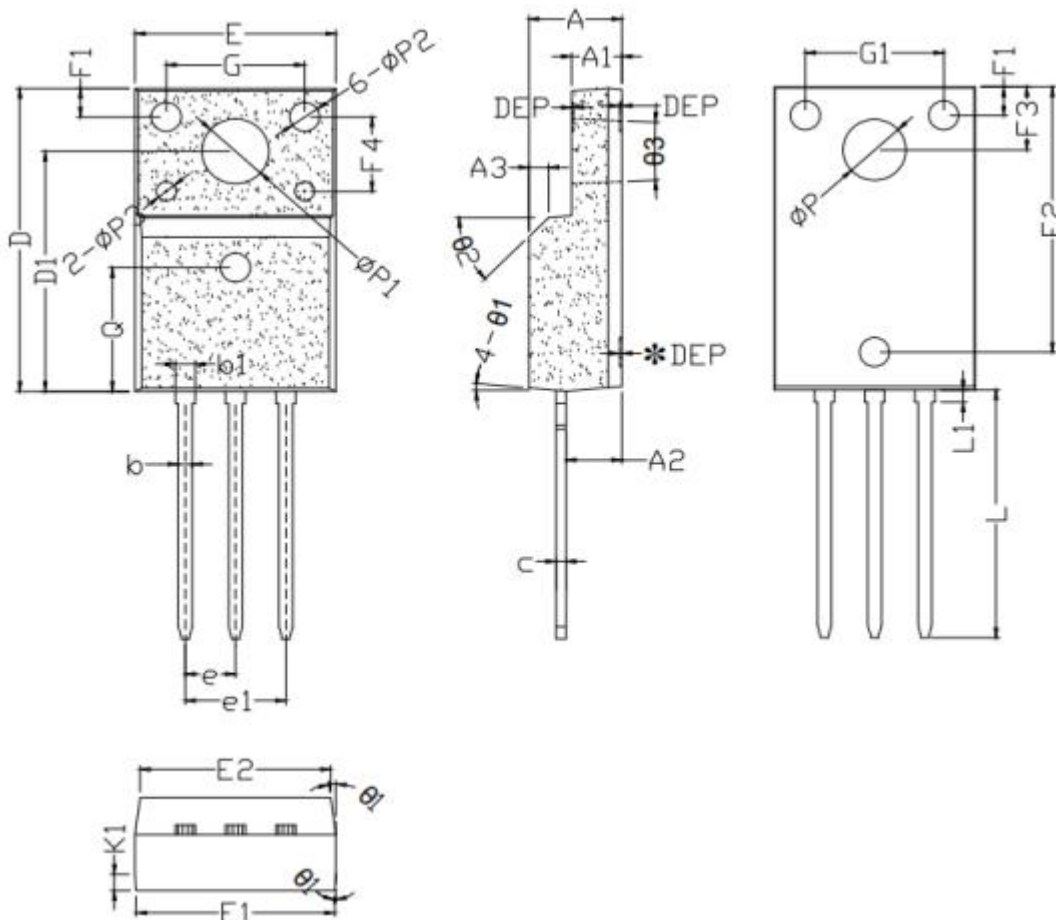



SME13N50-U

500V N-Channel MOSFET

注意事项:

- 1、在电路设计时请不要超过器件的最大额定值，否则会影响整机的可靠性。
- 2、MOSFET产品为静电敏感型器件，使用时应注意采取防静电保护措施，如佩戴防静电手环、设备接地等。
- 3、如需安装散热片，请注意控制扭力大小及散热片的平整度。
- 4、该规格书由华科公司制作，并可能不定期更改，恕不另行通知。
- 5、如有疑问，请及时联系我司销售代表。

版本履历表:

序号	版本号	修改时间	修改记录
1	V1.0	2022-12-20	首次发行