



HCD65R380-S2

650V N-Channel Super Junction Power MOSFET

● Features:

- 11.0A, 650V, $R_{DS(on)(Typ)} = 320m\Omega @ V_{GS}=10V$
- Low Gate Charge
- Low C_{rSS}
- 100% Avalanche Tested
- Fast Switching
- Improved dv/dt Capability

● Application:

- High Frequency Switching Mode Power Supply
- Active Power Factor Correction

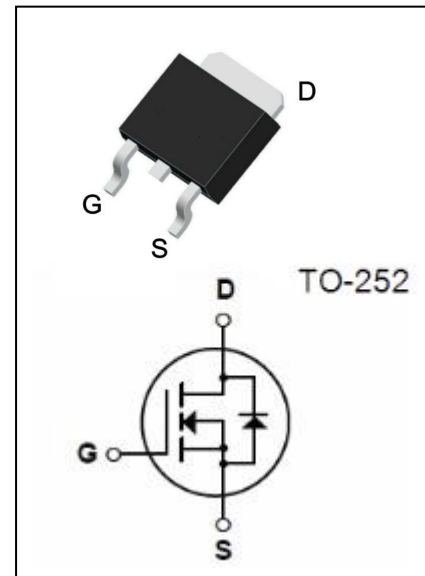

Absolute Maximum Ratings ($T_c=25^\circ C$ unless otherwise noted)

Symbol	Parameter	Value	Unit
V_{DSS}	Drain-Source Voltage	650	V
I_D	Drain Current - Continuous ($T_c=25^\circ C$) - Continuous ($T_c=100^\circ C$)	11.0*	A
		6.96*	A
I_{DM}	Drain Current - Pulsed (Note1)	44.0*	A
V_{GSS}	Gate-Source Voltage	± 30	V
E_{AS}	Single Pulsed Avalanche Energy (Limit Reference Value) (Note2)	106	mJ
I_{AR}	Avalanche Current (Note1)	2.2	A
E_{AR}	Repetitive Avalanche Energy (Note1)	2.7	mJ
dv/dt	Peak Diode Recovery dv/dt (Note3)	8.5	V/ns
P_D	Power Dissipation ($T_c = 25^\circ C$) - Derate above $25^\circ C$	91	W
		0.73	W/ $^\circ C$
T_j	Operating Junction Temperature	150	$^\circ C$
T_{stg}	Storage Temperature Range	-55 to +150	$^\circ C$

* Drain Current Limited by Maximum Junction Temperature.

Thermal Characteristics

Symbol	Parameter	Max	Unit
$R_{\theta JC}$	Thermal Resistance, Junction to Case	1.37	$^\circ C / W$
$R_{\theta JA}$	Thermal Resistance, Junction to Ambient	69	$^\circ C / W$



HCD65R380-S2

650V N-Channel Super Junction Power MOSFET

Electrical Characteristics(Tc=25°C unless otherwise noted)

Symbol	Parameter	Test Conditions	Min	Typ	Max	Unit
Off Characteristics						
BV_{DSS}	Drain-source Breakdown Voltage	$V_{GS}=0V, I_D=250\mu A$	650	--	--	V
$\Delta BV_{DSS} / \Delta T_J$	Breakdown Voltage Temperature Coefficient	$I_D=250\mu A$ (Referenced to 25°C)	--	0.64	--	V/°C
I_{DSS}	Zero Gate Voltage Drain Current	$V_{DS}=650V, V_{GS}=0V$	--	--	1	μA
		$V_{DS}=520V, T_c=125^\circ C$	--	--	10	μA
I_{GSSF}	Gate-Body Leakage Current, Forward	$V_{GS}=+30V, V_{DS}=0V$	--	--	100	nA
I_{GSSR}	Gate-Body Leakage Current, Reverse	$V_{GS}=-30V, V_{DS}=0V$	--	--	-100	nA
On Characteristics						
$V_{GS(th)}$	Gate Threshold Voltage	$V_{DS}=V_{GS}, I_D=250\mu A$	2.3	--	4.5	V
$R_{DS(on)}$	Static Drain-Source On-Resistance	$V_{GS}=10V, I_D=5.5A$	--	320	380	m Ω
g_{FS}	Forward Transconductance	$V_{DS}=20V, I_D=5.5A$ (Note4)	--	6.1	--	S
Dynamic Characteristics						
C_{iss}	Input Capacitance	$V_{DS}=100V, V_{GS}=0V,$ $f=1.0MHz$	--	748	--	pF
C_{oss}	Output Capacitance		--	32	--	pF
C_{rss}	Reverse Transfer Capacitance		--	0.9	--	pF
Switching Characteristics						
$t_{d(on)}$	Turn-On Delay Time	$V_{DD} = 325V, I_D = 11.0A,$ $R_G = 25\Omega$ (Note4,5)	--	35	--	ns
t_r	Turn-On Rise Time		--	60	--	ns
$t_{d(off)}$	Turn-Off Delay Time		--	49	--	ns
t_f	Turn-Off Fall Time		--	28	--	ns
Q_g	Total Gate Charge	$V_{DS} = 520V, I_D = 11.0A,$ $V_{GS} = 10V$ (Note4,5)	--	20	--	nC
Q_{gs}	Gate-Source Charge		--	6.1	--	nC
Q_{gd}	Gate-Drain Charge		--	9.8	--	nC
Drain-Source Diode Characteristics and Maximum Ratings						
I_S	Maximum Continuous Drain-Source Diode Forward Current		--	--	11.0	A
I_{SM}	Maximum Pulsed Drain-Source Diode Forward Current		--	--	44	A
V_{SD}	Drain-Source Diode Forward Voltage	$V_{GS} = 0V, I_S = 11.0A$	--	--	1.4	V
t_{rr}	Reverse Recovery Time	$V_{GS} = 0V, I_S = 11.0A,$ $dI_f/dt = 100A/\mu s$ (Note4)	--	320	--	ns
Q_{rr}	Reverse Recovery Charge		--	4.2	--	μC

Notes:

- 1、Repetitive Rating:Pulse Width Limited by Maximum Junction Temperature.
- 2、L = 40mH, $I_{AS} = 2.2A, V_{DD} = 100V, R_G = 25\Omega$, Starting $T_J = 25^\circ C$.
- 3、 $I_{SD} \leq 11.0A, di/dt \leq 200A/\mu s, V_{DD} \leq BV_{DSS}$, Starting $T_J = 25^\circ C$.
- 4、Pulse Test : Pulse Width $\leq 300\mu s$, Duty Cycle $\leq 2\%$.
- 5、Essentially Independent of Operating Temperature.



HCD65R380-S2

650V N-Channel Super Junction Power MOSFET

On-Regin Characteristics

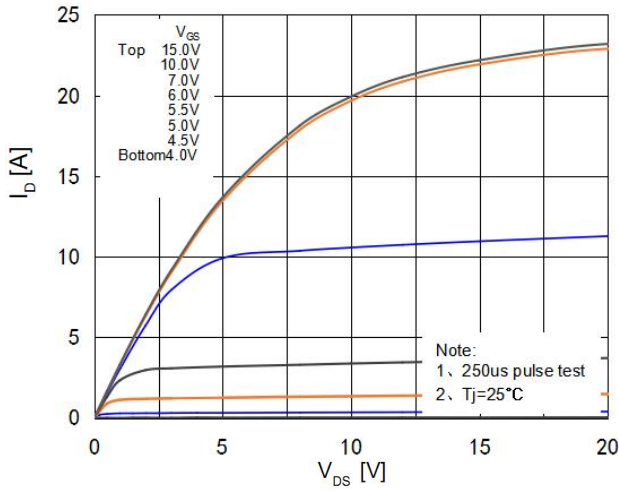

Transfer Characteristics

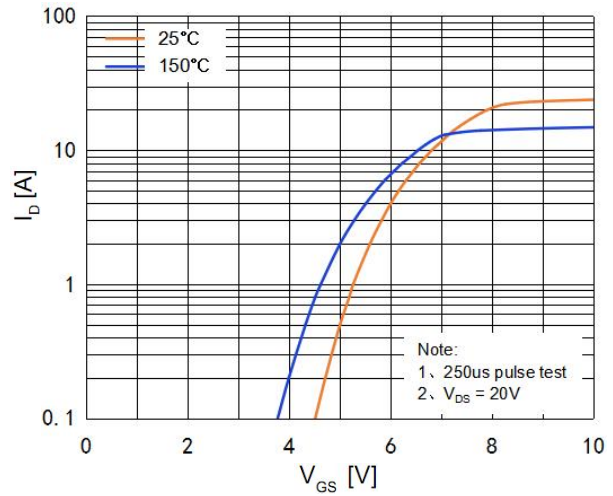

On-Resistance Variation vs. Drain Current and Gate Voltage

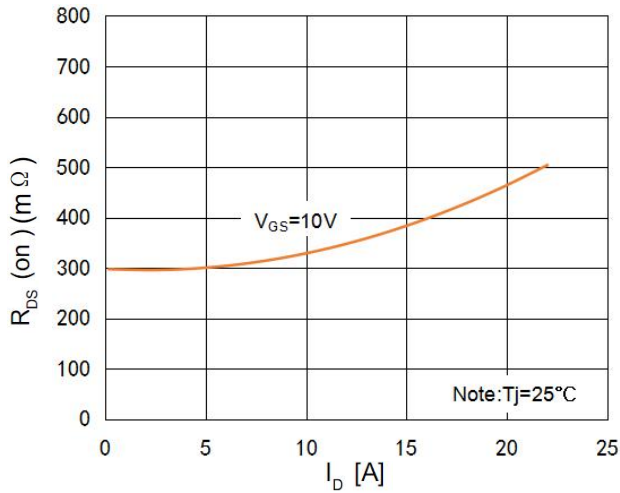

Body Diode Forward Voltage Variation vs. Source Current and Temperature

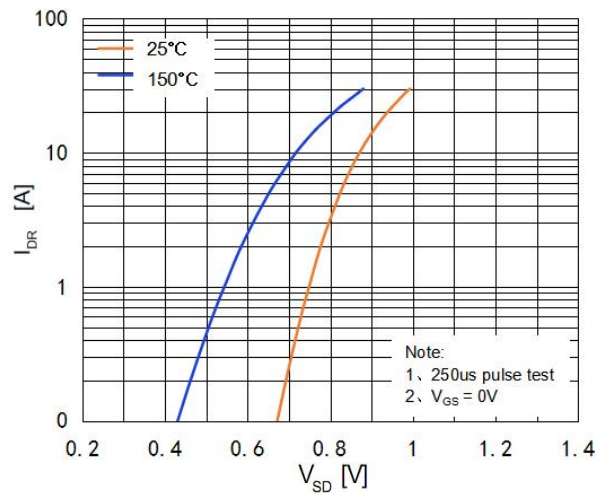

Capacitance Characteristics

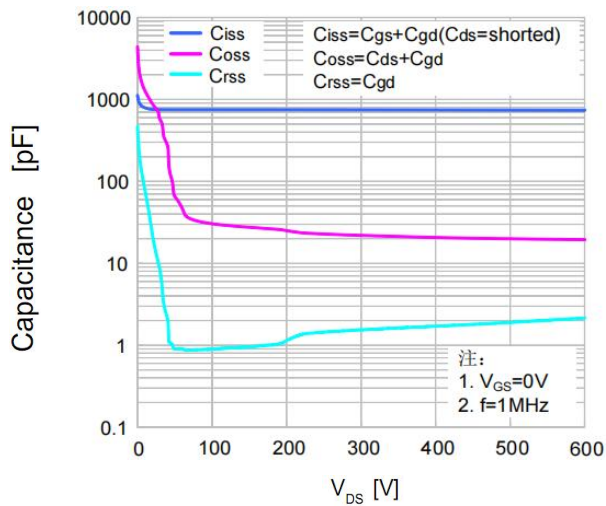

Gate Charge Characteristics

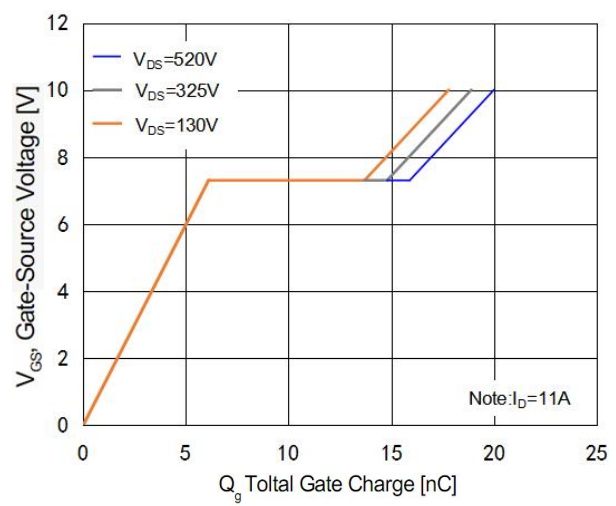

Breakdown Voltage Variation vs. Temperature

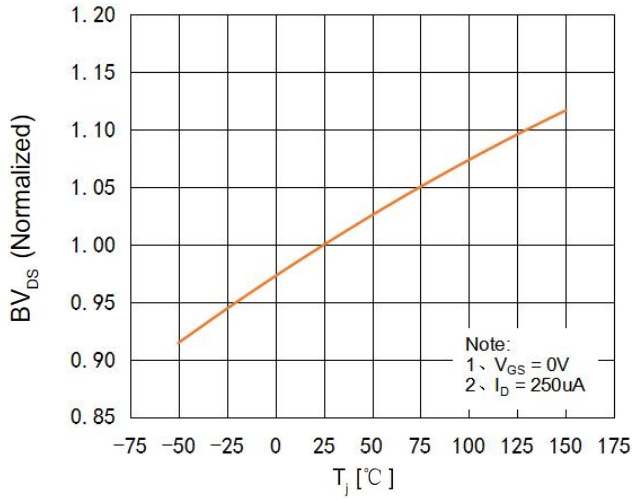

On-Resistance Variation vs. Temperature

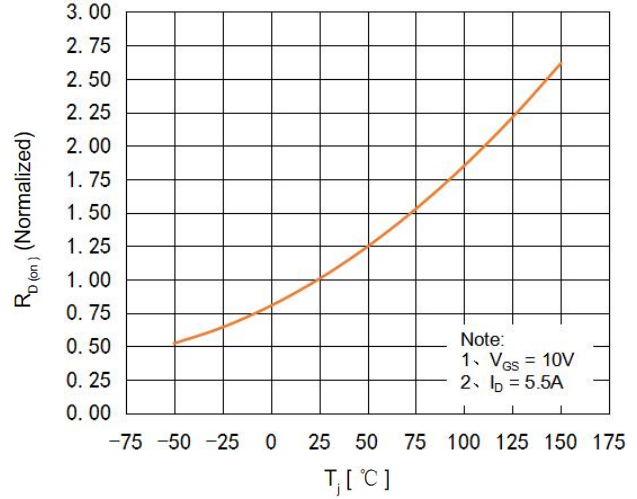

Maximum Safe Operating Area

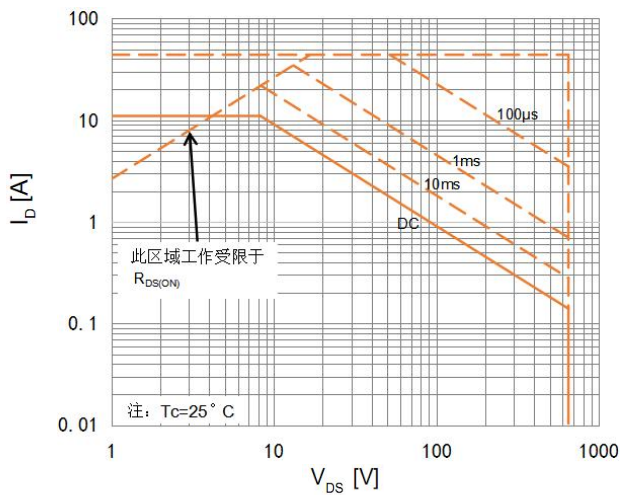

Maximum Drain Current Vs. Case Temperature

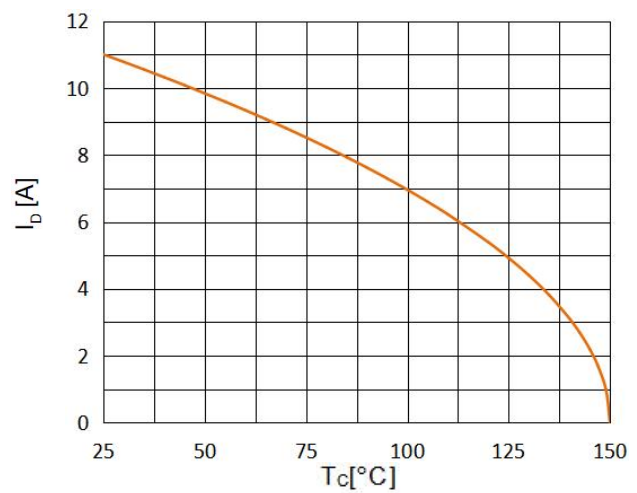



HCD65R380-S2

650V N-Channel Super Junction Power MOSFET

TO-252 Package Dimensions

UNIT: mm

SYMBOL	min	nom	max	SYMBOL	min	nom	max
A	6.40		6.60	D	2.90		3.10
A1	5.20		5.40	D1	0.45		0.55
A2	4.40		4.60	D2	0.45		0.55
A3	4.40		4.60	e		2.30	
A4	0		0.15	E	2.20		2.40
A5	4.65		4.95	F	0.45		0.55
B	5.90		6.20	G		1.70	
B1	1.57		1.77	L	1.40		1.60
C	0.90		0.96	θ (度)	0		10.00

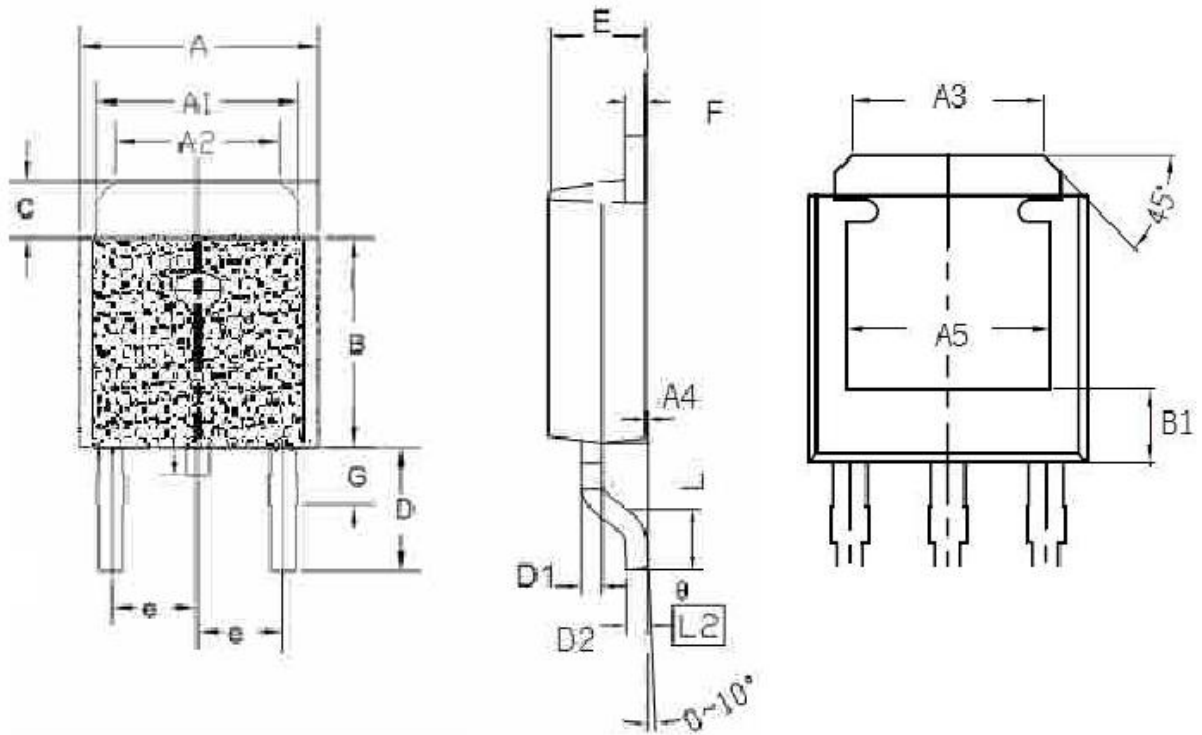



HCD65R380-S2

650V N-Channel Super Junction Power MOSFET

注意事项:

- 1、在电路设计时请不要超过器件的最大额定值，否则会影响整机的可靠性。
- 2、MOSFET产品为静电敏感型器件，使用时应注意采取防静电保护措施，如佩戴防静电手环、设备接地等。
- 3、如需安装散热片，请注意控制扭力大小及散热片的平整度。
- 4、该规格书由华科公司制作，并可能不定期更改，恕不另行通知。
- 5、如有疑问，请及时联系我司销售代表。

版本履历表:

序号	版本号	修改时间	修改记录
1	V1.0	2023-3-28	首次发行