



HTD100N03-U

30V N-Channel MOSFET

● **Features:**

- 100A, 30V, $R_{DS(on)(Typ)} = 3.3m\Omega @ V_{GS}=10V$
- Low Gate Charge
- Low C_{rss}
- 100% Avalanche Tested
- Fast Switching
- Improved dv/dt Capability

● **Application:**

- High Frequency Switching Mode Power Supply
- Active Power Factor Correction

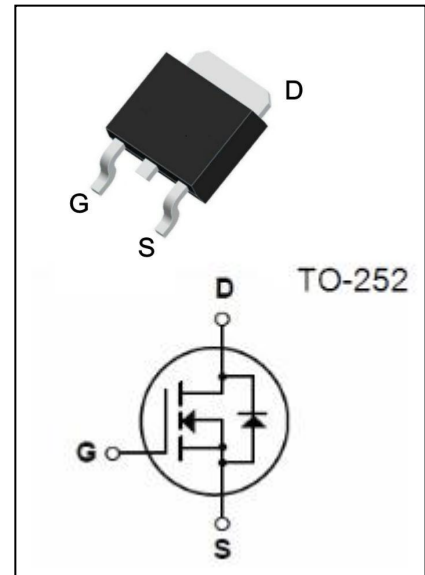

Absolute Maximum Ratings($T_c=25^\circ C$ unless otherwise noted)

Symbol	Parameter	Value	Unit
V_{DSS}	Drain-Source Voltage	30	V
I_D	Drain Current - Continuous($T_c=25^\circ C$, Silicon limit)	100	A
	Drain Current - Continuous($T_c=25^\circ C$, Package limit)	80	A
	Drain Current - Continuous($T_c=100^\circ C$, Silicon limit)	63.2	A
I_{DM}	Drain Current -Pulsed	240*	A
V_{GSS}	Gate-Source Voltage	± 20	V
E_{AS}	Single Pulsed Avalanche Energy (Limit Reference Value) (Note5)	119	mJ
P_D	Power Dissipation($T_c =25^\circ C$) -Derate above $25^\circ C$	58	W
		0.46	W/ $^\circ C$
T_j	Operating Junction Temperature	150	$^\circ C$
T_{stg}	Storage Temperature Range	-55 to+150	$^\circ C$

Thermal Characteristics

Symbol	Parameter	Max	Unit
$R_{\theta JC}$	Thermal Resistance,Junction to Case (Note2)	2.16	$^\circ C /W$



HTD100N03-U

30V N-Channel MOSFET

Electrical Characteristics(Tc=25°C unless otherwise noted)

Symbol	Parameter	Test Conditons	Min	Typ	Max	Unit
Off Characteristics						
BV _{DSS}	Drain-source Breakdown Voltage	V _{GS} =0V ,I _D =250μA	30	--	--	V
I _{DSS}	Zero Gate Voltage Drain Current	V _{DS} =30V, V _{GS} =0V	--	--	1	μA
I _{GSSF}	Gate-Body Leakage Current,Forward	V _{GS} =+20V, V _{DS} =0V	--	--	100	nA
I _{GSSR}	Gate-Body Leakage Current,Reverse	V _{GS} =-20V, V _{DS} =0V	--	--	-100	nA
On Characteristics (Note3)						
V _{GS(th)}	Gate Threshold Voltage	V _{DS} = V _{GS} , I _D =250μA	1.0	1.6	2.5	V
R _{DS(on)}	Static Drain-Source On-Resistance	V _{GS} =10 V, I _D =40A	--	3.3	4.5	mΩ
R _{DS(on)}	Static Drain-Source On-Resistance	V _{GS} =4.5 V, I _D =40A	--	5.5	7.5	mΩ
Dynamic Characteristics (Note4)						
C _{iss}	Input Capacitance	V _{DS} =15V, V _{GS} =0V, f=1.0MHz	--	3130	--	pF
C _{oss}	Output Capacitance		--	353	--	pF
C _{rss}	Reverse Transfer Capacitance		--	305	--	pF
Switching Characteristics (Note4)						
t _{d(on)}	Turn-On Delay Time	V _{DD} = 15 V, I _D =20 A, R _G =2.5Ω, V _{GS} =10V	--	13.5	--	ns
t _r	Turn-On Rise Time		--	18	--	ns
t _{d(off)}	Turn-Off Delay Time		--	59	--	ns
t _f	Turn-Off Fall Time		--	17	--	ns
Q _g	Total Gate Charge	V _{DS} =15 V, I _D =20A, V _{GS} = 10 V	--	51	--	nC
Q _{gs}	Gate-Source Charge		--	12	--	nC
Q _{gd}	Gate-Drain Charge		--	11	--	nC
Drain-Source Diode Characteristics and Maximum Ratings						
I _S	Maximum Continuous Drain-Source Diode Forward Current (Note2)		--	--	100	A
I _{SM}	Maximum Pulsed Drain-Source Diode Forward Current		--	--	240	A
V _{SD}	Drain-Source Diode Forward Voltage	V _{GS} =0V, I _S =40A (Note3)	--	--	1.4	V
t _{rr}	Reverse Recovery Time	V _{GS} =0V, I _S =20A, d I _F /dt=100A/μs (Note3)	--	42	--	ns
Q _{rr}	Reverse Recovery Charge		--	33	--	nC

Notes:

- 1、Repetitive Rating:Pulse Width Limited by Maximum Junction Temperature.
- 2、Surface Mounted on FR4 Board, t ≤ 10 sec.
- 3、Pulse Test : Pulse Width ≤300 μ s, Duty Cycle≤2%.
- 4、Guaranteed by design, not subject to production.
- 5、EAS condition: L = 0.5mH, I_{AS} =17A, V_{DD} = 20V, R_G = 25 Ω, Starting T_J = 25°C.



HTD100N03-U

30V N-Channel MOSFET

On-Regin Characteristics

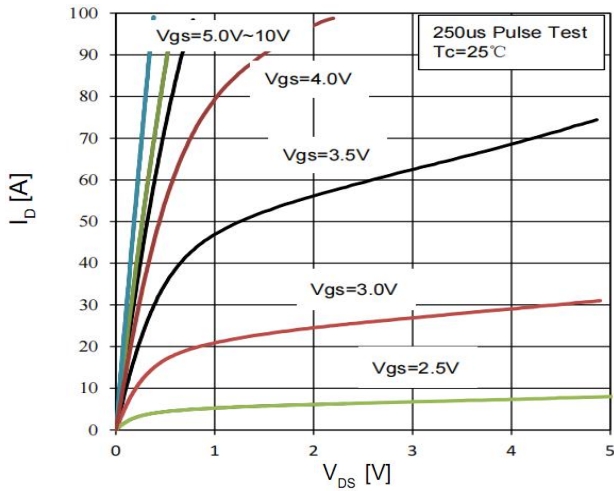

Transfer Characteristics

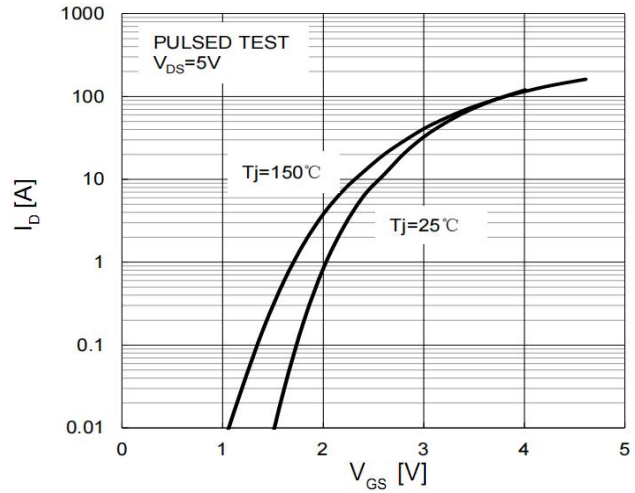

On-Resistance Variation vs. Drain Current and Gate Voltage

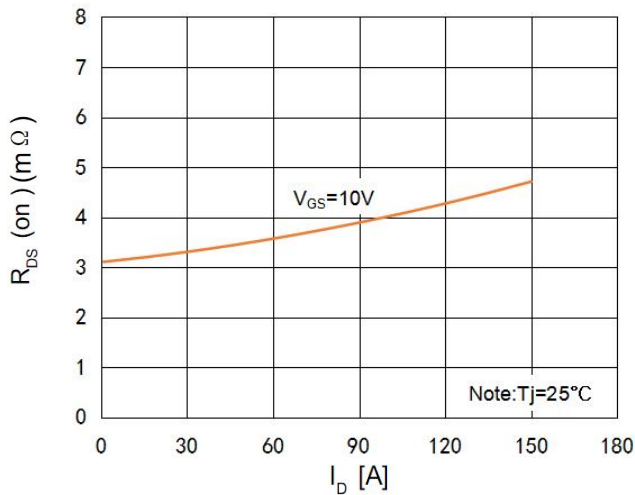

Body Diode Forward Voltage Variation vs. Source Current and Temperature

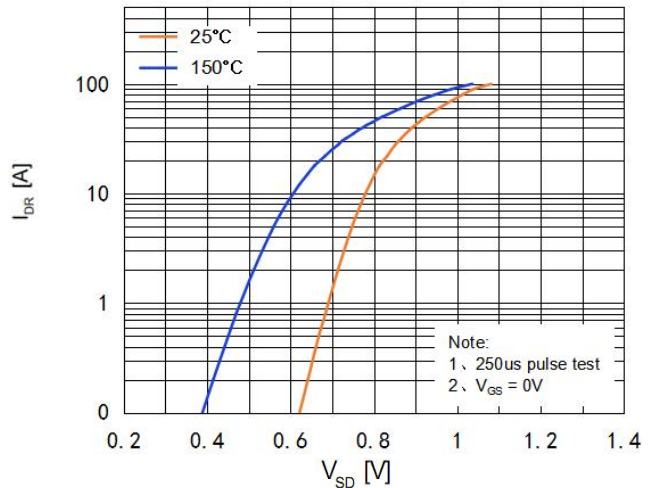

Capacitance Characteristics

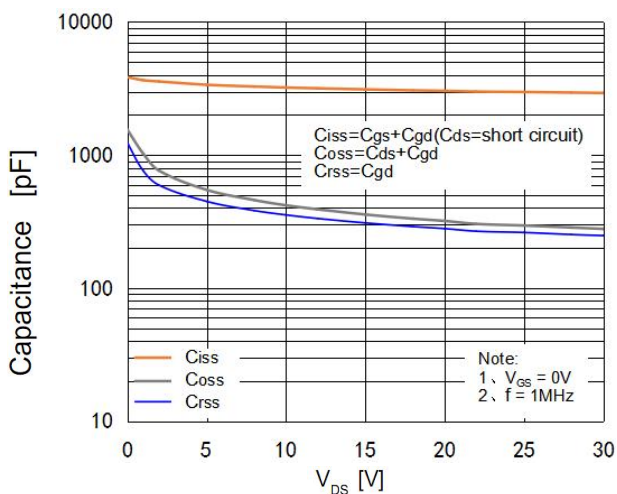

Gate Charge Characteristics

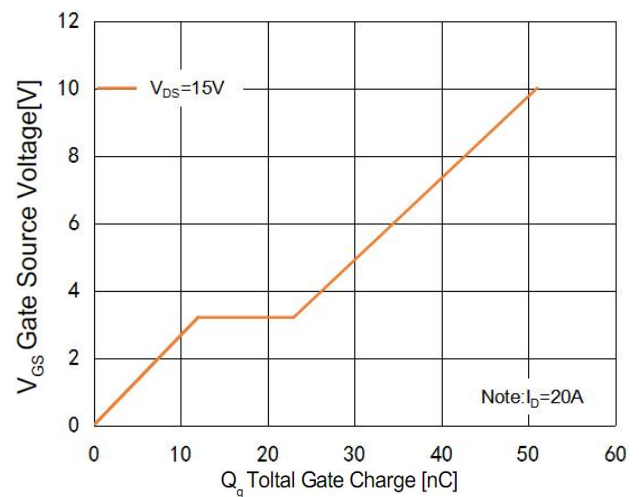

Breakdown Voltage Variation vs. Temperature

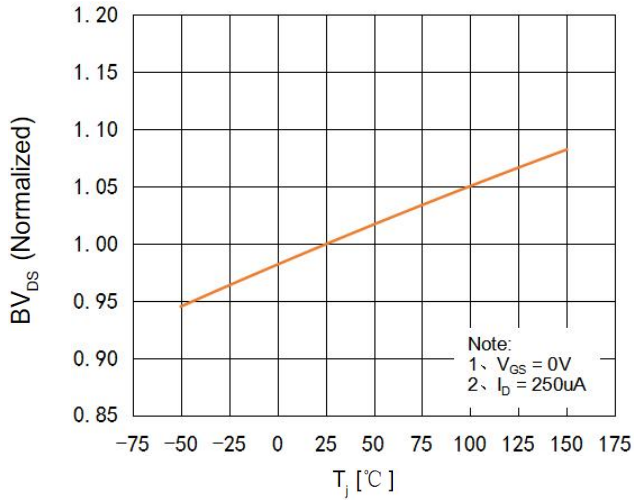

On-Resistance Variation vs. Temperature

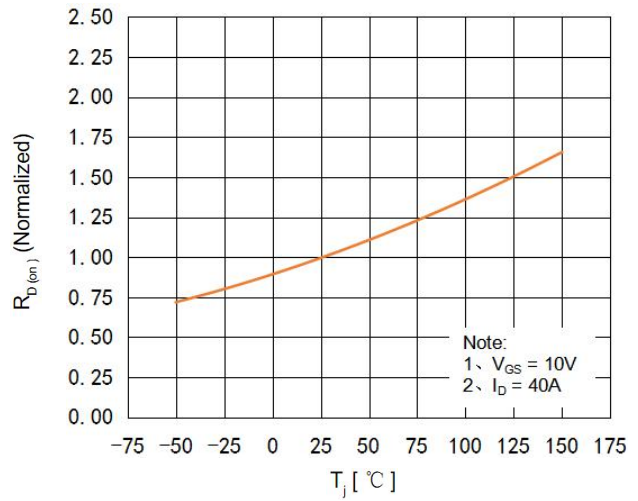

Maximum Safe Operating Area

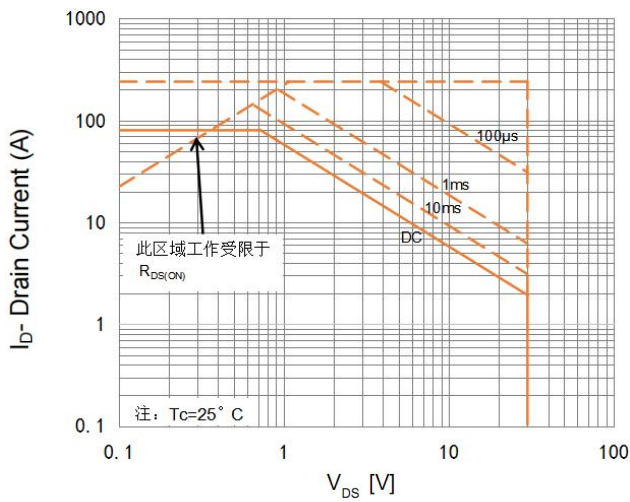

Maximum Drain Current Vs. Case Temperature

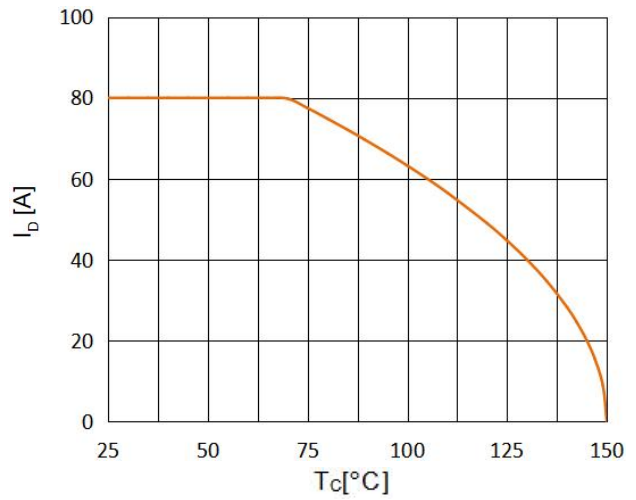



HTD100N03-U

30V N-Channel MOSFET

TO-252 Package Dimensions

UNIT: mm

SYMBOL	min	nom	max	SYMBOL	min	nom	max
A	6.40		6.60	D	2.90		3.10
A1	5.20		5.40	D1	0.45		0.55
A2	4.40		4.60	D2	0.45		0.55
A3	4.40		4.60	e		2.30	
A4	0		0.15	E	2.20		2.40
A5	4.65		4.95	F	0.45		0.55
B	5.90		6.20	G		1.70	
B1	1.57		1.77	L	1.40		1.60
C	0.90		0.96	θ (度)	0		10.00

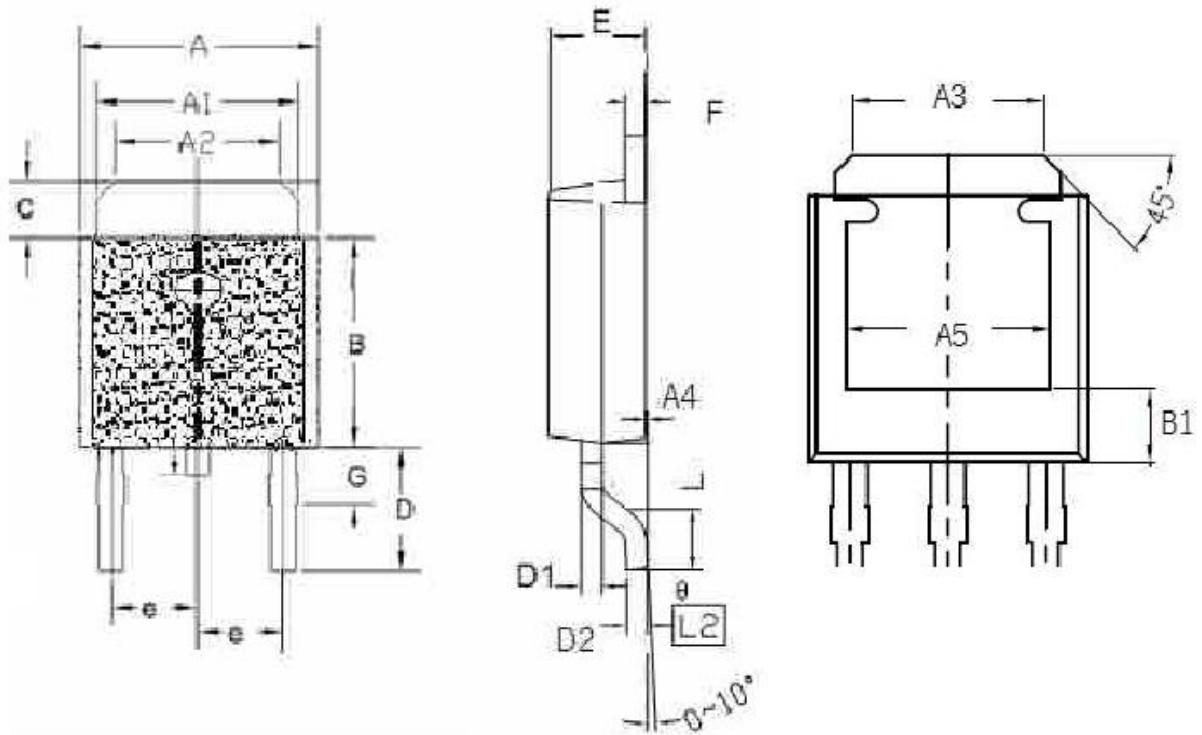



HTD100N03-U

30V N-Channel MOSFET

注意事项:

- 1、在电路设计时请不要超过器件的最大额定值，否则会影响整机的可靠性。
- 2、MOSFET产品为静电敏感型器件，使用时应注意采取防静电保护措施，如佩戴防静电手环、设备接地等。
- 3、如需安装散热片，请注意控制扭力大小及散热片的平整度。
- 4、该规格书由华科公司制作，并可能不定期更改，恕不另行通知。
- 5、如有疑问，请及时联系我司销售代表。

版本履历表:

序号	版本号	修改时间	修改记录
1	V1.0	2023-9-20	首次发行